

NOTA: raccomandiamo che questo prodotto sia installato da personale professionale. In caso ci siano dubbi sull'installazione, contattate il rivenditore per assistenza.

Attrezzi richiesti per l'installazione:

Trapano elettrico con punta per muri 10 mm.

Cacciavite a stella

IMPORTANTE:







Per ragioni di sicurezza il soffitto o il muro dove viene installato la staffa deve essere in grado di supportare il peso combinato del supporto e del dispositivo: altrimenti la struttura deve essere rinforzata.

Sono necessarie almeno due persone per l'installazione. Non si raccomanda l'installazione da parte di una sola persona.

Assicuratevi che nel muro dove viene installata la staffa non passino cavi elettrici, condutture di acqua o tubi del gas.

Durante l'installazione indossare protezioni adeguate.

Assicuratevi che questi accessori siano inclusi nella confezione:

- | | | | | | |
|----------------------------|---|--------------------------|--|-----------------------|---|
| (A) Viti da muro M6x50 x 6 |  | (B) Tasselli da muro x 6 |  | (C) Distanziatori x 6 |  |
| (D) Bullone M6x20x4 |  | (E) Bullone M8x20x 4 |  | (F) Spaziatore x 4 |  |
| (G) Distanziatore x 4 |  | | | | |

Installazione della staffa a muro

Installazione su calcestruzzo o mattoni

1

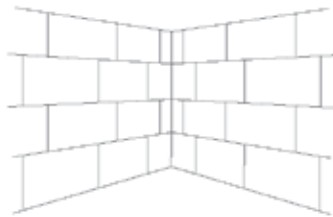

Centro del supporto

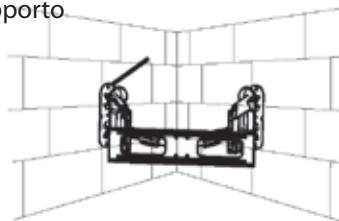

Misuratore a nastro



Usate una matita per segnare il punto di 4 o 6 fori

2

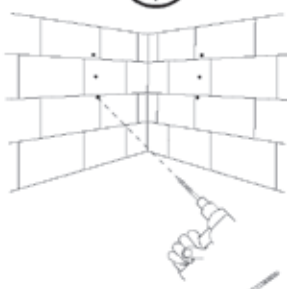

Inserite un tassello (B) in ogni foro

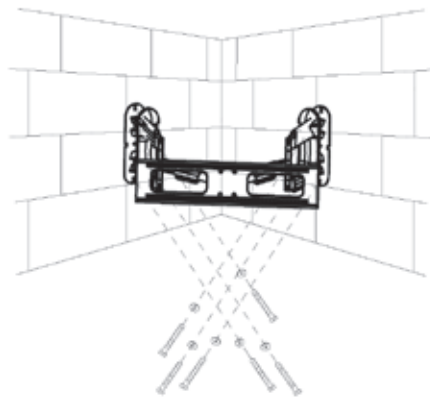

3

4

Fissate la parte fissa a muro usando le viti a muro (A) fornite

Installate lo schermo sul supporto

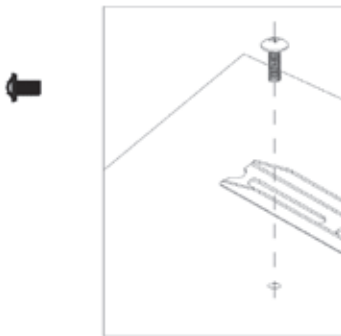

6

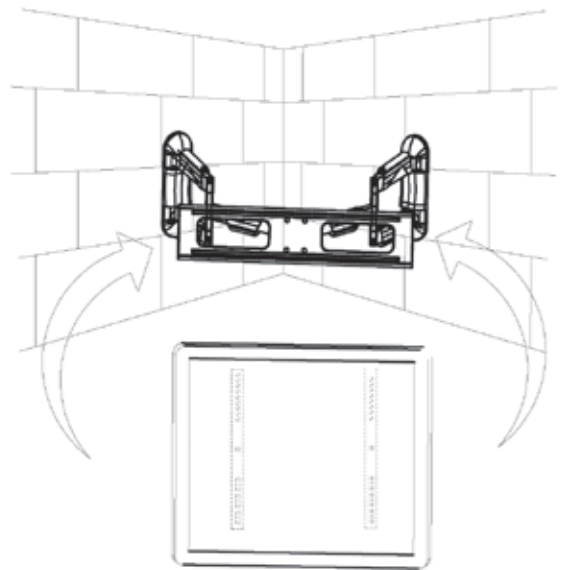

5

8

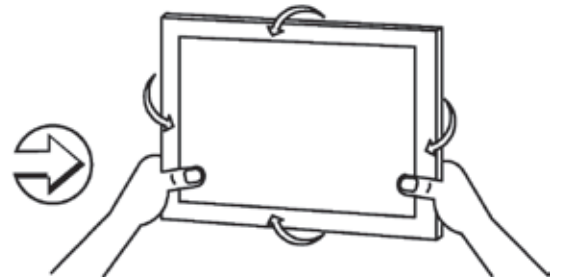

7

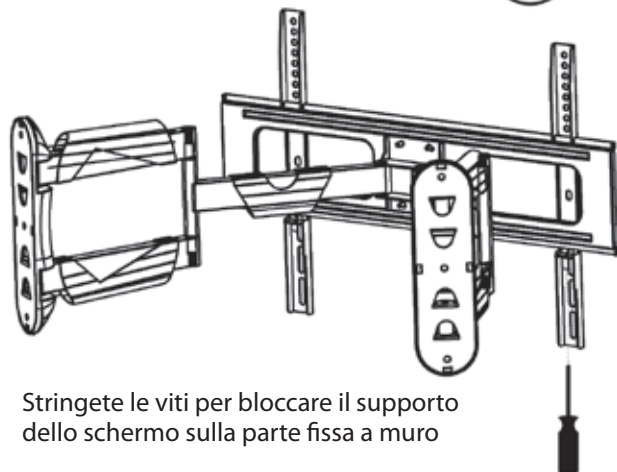

Stringete le viti per bloccare il supporto dello schermo sulla parte fissa a muro