



ADVANCED NETWORK SURVEILLANCE DOME CAMERA

INSTALLATION GUIDE

Please read instructions thoroughly before operation and retain it for future reference.

1. 1. OVERVIEW

1.1 Package Content

⊙ In the camera package:

- | | |
|---|--|
| <input type="checkbox"/> PTZ network camera | <input type="checkbox"/> Quick Start |
| <input type="checkbox"/> CD-ROM disc (including user manuals & CMS software "Video Viewer") | <input type="checkbox"/> RJ45 cable extender adapter |

⊙ In the bracket package (Optional) :

- | | |
|--|---|
| <input type="checkbox"/> Wall mounting screws x 4 | <input type="checkbox"/> Wall plugs x 4 |
| <input type="checkbox"/> Cap x 1 | <input type="checkbox"/> Bracket screw x 1 |
| <input type="checkbox"/> M6 Nylok screws (short) x 2 | <input type="checkbox"/> M6 Nylok screws (long) x 3 |
| <input type="checkbox"/> M4 screw x 1 | <input type="checkbox"/> Mounting base screw x 2 |
| <input type="checkbox"/> Spirit level x 1 | <input type="checkbox"/> Hex screw nuts x 3 |

1.2 Dimensions

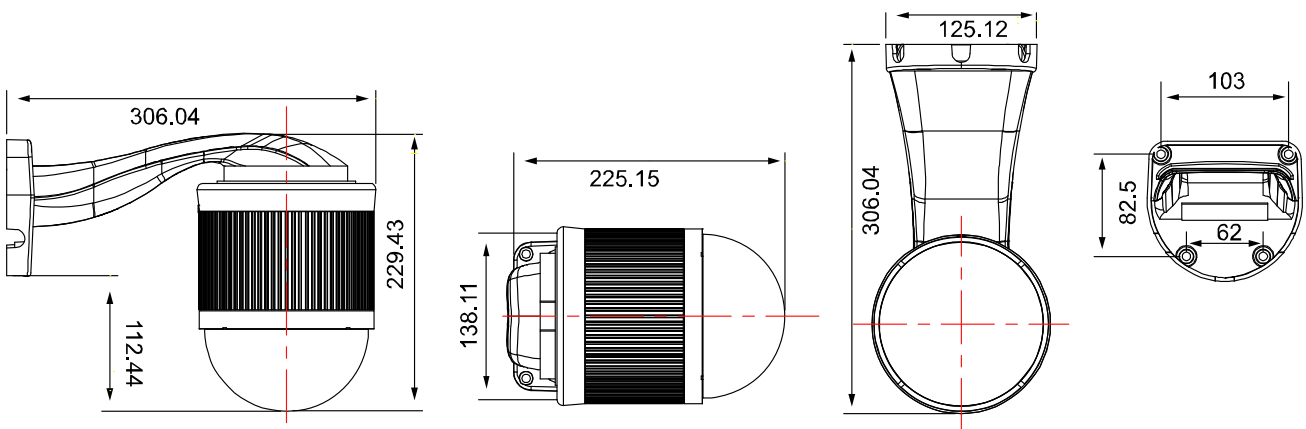

1.2 Cable Overview

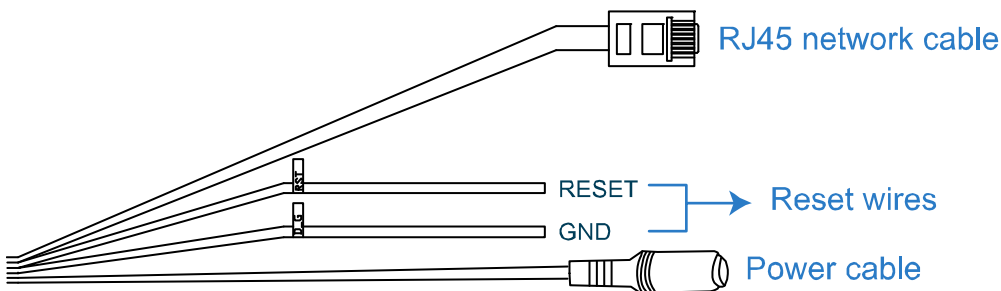

CABLE	DESCRIPTION
RJ45 network cable	Connect it to the supplied RJ45 cable extender adapter for cable extension, and prepare another RJ45 network cable with suitable length for your connection.
Reset wires	Remove the insulating coating of these two wires, and twist them together to reset default. This will reset all parameters, including the IP address to factory default settings. Note: Disconnect power before twisting these two wires together, and connect to power again for reset default.
Power cable	Connect to DC12V power supply.

2. INSTALLATION & CONNECTION

2.1 Install the Camera

Before installation, you need the following items before installation:

- Bracket & Camera Mounting Base (supplied with the bracket sales package)
- The accessory packages supplied with the bracket sales package, including:

(1) Wall mounting screws x 4	(2) Wall plugs x 4
(3) Cap x 1	(4) Bracket screw x 1
(5) M6 Nylok screws (short) x 2	(6) M6 Nylok screws (long) x 3
(7) M4 screw x 1	(8) Mounting base screw x 2
(9) Spirit level x 1	(10) Hex screw nuts x 3
- Power Drill

Step1: Put hex screw nuts to the reserved holes on the camera-mounting base as indicated below.



- Find the camera-mounting base and the supplied three hex screw nuts in the bracket package.
- Find the reserved holes for hex screw nuts on the camera-mounting base, and push each nut into each reserved hole hardly.

Step2: Attach the camera-mounting base to the speed dome camera.



- Put all the cables through the hole of the camera-mounting base.
- Align the breach of the camera-mounting base with the arrow mark on the camera, and use two small M6 Nylok screws to fix the camera-mounting base to the camera.

Step3: Attach the bracket to the wall.



- a) The bracket is composed of two parts: the upper part and the bottom part. Remove the upper part by loosening the screw on it. Use the four mounting screws and wall plugs to attach the bottom part to the wall, as shown in the picture below.
- b) Use the spirit level supplied with the bracket package to check the surface is horizontal or not. If the surface is horizontal, the bubble will remain in the center circle of the spirit level.

Step4: Attach the camera to the bracket.

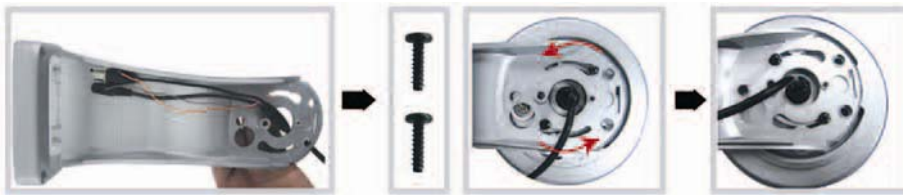

- a) Put the cables through the hole of the bracket.
- b) Attach the camera to the bracket with the two mounting base screws, and rotate the camera as indicated below. The camera will be hooked on the bracket.



- c) Slightly secure the camera and the bracket with the supplied three long M6 Nylok screws.
- d) Use the spirit level to check the surface is horizontal or not, and adjust the tightness of the three M6 Nylok screw.
- e) When you make sure the surface is horizontal, use the M4 screw supplied with the bracket package to fix the camera and the bracket tightly.

Step5: Connect the power, video, network & rest cables.



- a) Put the cables through the gap and connect the camera with the indicated power adapter, video cable, network cable.
- b) After connection, use the insulation tape to cover the connected wires and arrange the cables in the proper position again.

Step6: Replace the upper part of the bracket, and finish the installation.

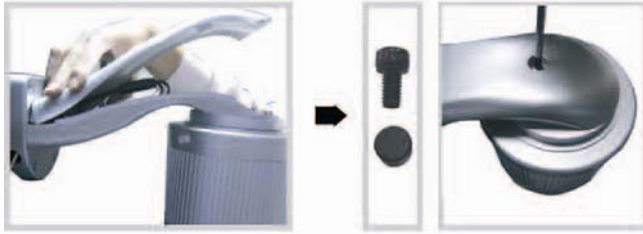

- a) Place the upper part of the bracket back to the bottom part of the bracket, and fasten the bracket with the screw indicated above.
- b) Then use the cap supplied with the package to cover the screw hole and finish the installation.

2.2 Connect to power

Connect the power adapter (optional) to the camera's power connector and power outlet.

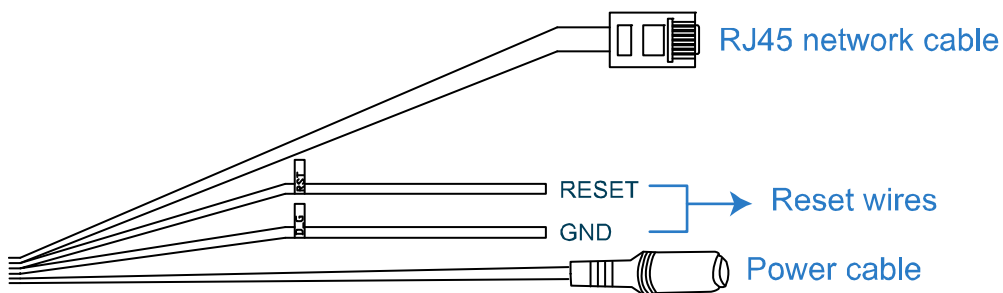

Note: The regulated power adapter is DC12V to operate this device.

3. ETHERNET CONNECTION

Before using this network camera, please follow the instructions below to finish the network connection settings based on your installation environment:

- To configure the network settings, you must connect the camera to your PC by LAN. For details, please refer to “3.1 Network Connection via LAN” at page 6.
- To configure the network settings via Wizard, please refer to “3.2 Network Configurations via Wizard” at page 10.
- To configure the network settings via our supplied CMS software, Video Viewer, please refer to “3.3 Network Configurations via Video Viewer” at page 14.

3.1 Network Connection via LAN

Step 1: Connect this network camera and your PC via a RJ45 network cable, and make sure the camera is powered on.

Step 2: Set the PC's IP address as “192.168.1.XXX” (1~255, except 10).

For Windows 2000 users:

- Select “Start” → “Settings” → “Network and Dial-up Connections”.
- Right-click on “Local Area Connection”, and select “Properties”.

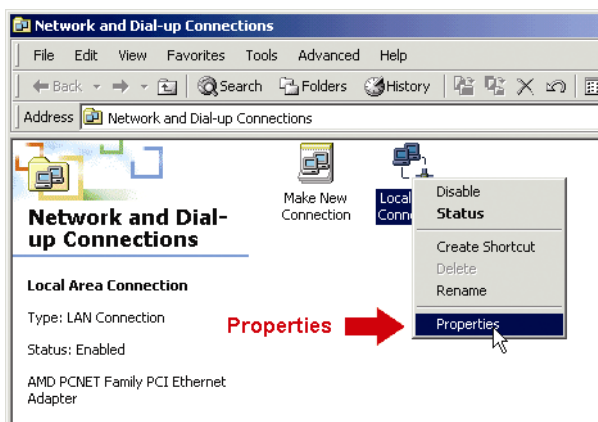

- In the “General” tab, select “Internet Protocol (TCP/IP)”, and select “Properties”.

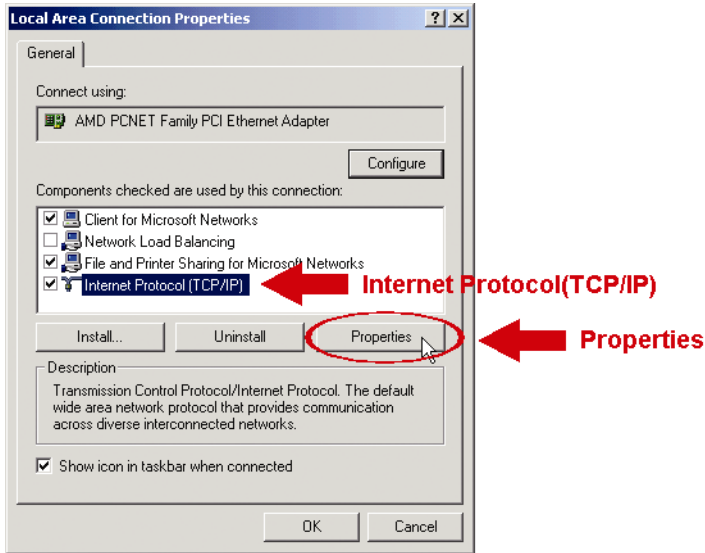

d) In the “General” tab, select “Use the following IP address”, and set the IP address as described below.

Note: It’s recommended to note down the current settings first and then change as instructed. It’s helpful when you need to restore the PC network settings for connecting to Internet later.

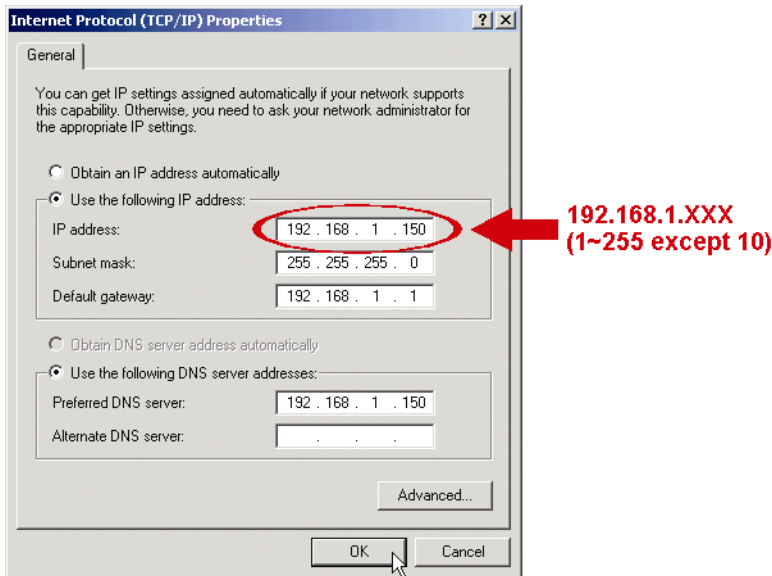

e) Click “OK” to close the “Internet Protocol (TCP/IP) Properties” dialog box. Then, click “Close” to close the “Local Area Connection Properties” dialog box.

For Windows XP users:

a) Select “start” → “All Programs” → “Control Panel” → “Network and Internet Connections” → “Network Connections” (If you’re in “Category View”).





b) In “LAN or High-Speed Internet”, right-click on “Local Area Connection”, and select “Properties”.

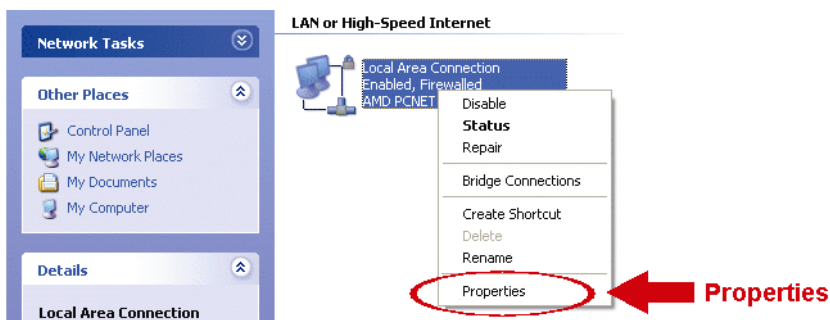

c) In the “General” tab, select “Internet Protocol (TCP/IP)”, and select “Properties”.

d) In the “General” tab, select “Use the following IP address”, and set the IP address to “192.168.1.XXX” (XXX can be any value from 1~255 except 10).

Note: It’s recommended to note down the current settings first and then change as instructed. It’s helpful when you need to restore the PC network settings for connecting to Internet later.

e) Click “OK” to close the “Internet Protocol (TCP/IP) Properties” dialog box. Then, click “Close” to close the “Local Area Connection Properties” dialog box.

For Windows Vista users:

a) Select “” (start) → “Control Panel” → “Network and Internet” to enter the “Network and Sharing Center”. Then, click “Manage network connections” (If you’re in “Category View”).

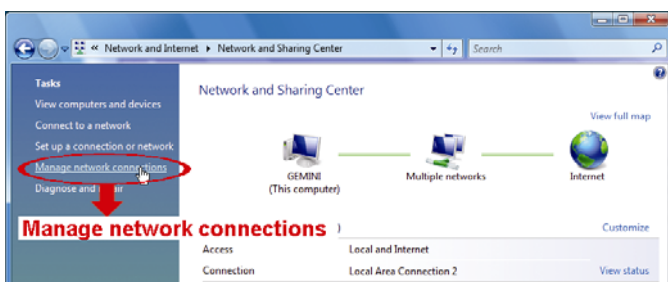

b) Right-click on “Local Area Connection”, and select “Properties”.



c) In the “General” tab, select “Internet Protocol Version 4 (TCP/IPv4)”, and select “Properties”.

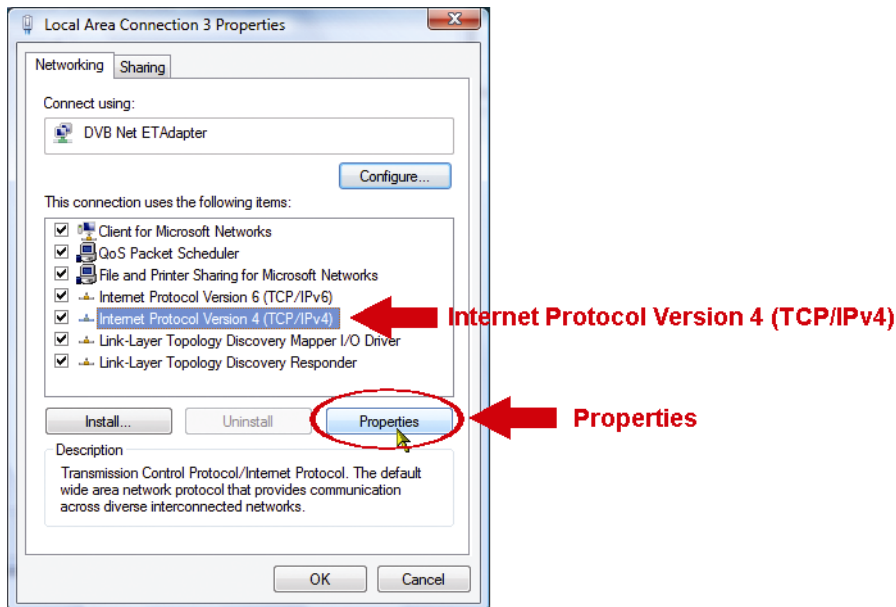

d) In the “General” tab, select “Use the following IP address”, and set the IP address as described below.

Note: It’s recommended to note down the current settings first and then change as instructed. It’s helpful when you need to restore the PC network settings for connecting to Internet later.

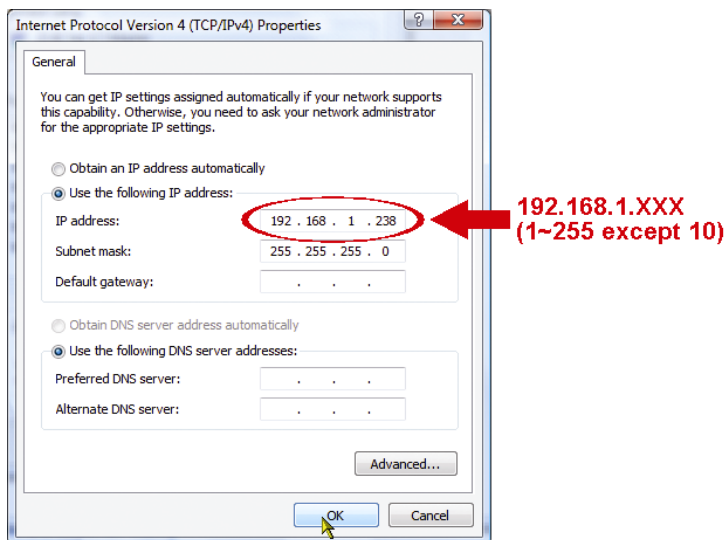

e) Click “OK” to close the “Internet Protocol Version 4 (TCP/IPv4) Properties” dialog box. Then, click “Close” to close the “Local Area Connection Properties” dialog box.

3.2 Network Configurations via Wizard

A quick installation wizard is available via your web browser for password change, date & time settings, and network configurations.

- For details about the wizard, please refer to “3.2.1 Setting in Wizard” at page 10.
- For details about DDNS setting for PPPoE and DHCP, please refer to “3.2.2 DDNS Setting” at page 12.

Note: You can also change the settings in the system configuration page via your web browser later. For details, please refer to “5. ACCESSING THE CAMERA VIA WEB BROWSER” in the user manual.

3.2.1 Setting in Wizard

Step1: Open your web browser, for example, Microsoft Internet Explorer, and enter “<http://192.168.1.10>” in the URL address box.

Step2: In the login page, key in the default user name (*admin*) and password (*admin*), and enter the security code from the image below. Then, click “LOGIN”.



Step3: The wizard is then starting analyzing your network environment, and shows your network environment. Select “Next” to continue.

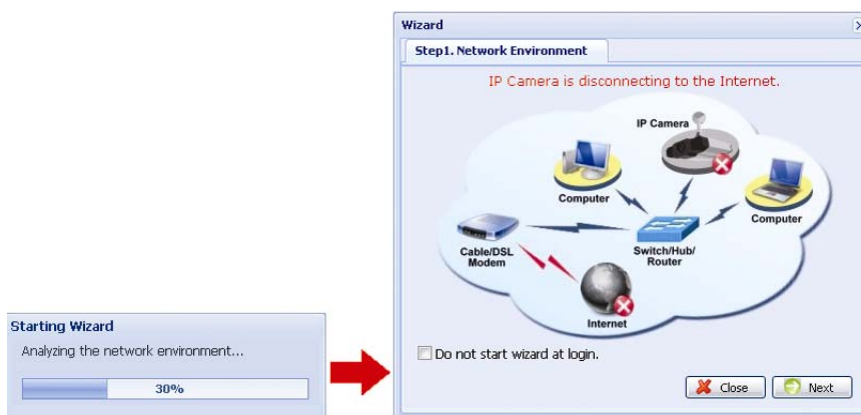

Step4: In “Account”, change the access password if needed. If not, leave all the columns blank, and select “Next”.



The screenshot shows the 'Step2: Account' configuration screen in a 'Wizard' window. It contains four text input fields: 'Username' with 'admin', 'Password' with '*****', 'New Password' with '*****', and 'Confirm Password' with '*****'. There is a small cartoon character icon and 'Back' and 'Next' buttons at the bottom.

Step5: In “Date and Time”, check if the date and time setting are correct and modify if necessary.

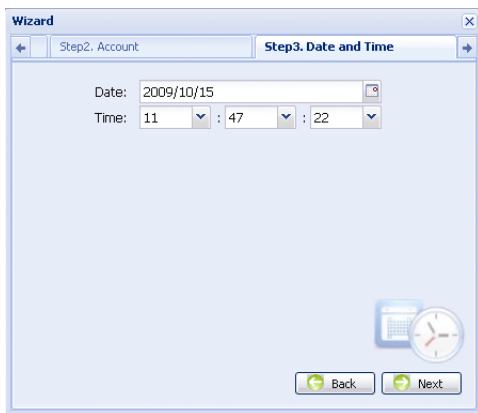

The screenshot shows the 'Step3: Date and Time' configuration screen in a 'Wizard' window. It features a date picker set to '2009/10/15' and a time picker set to '11:47:22'. There is a clock icon and 'Back' and 'Next' buttons at the bottom.

Step6: In “Network”, select the network type based on your network environment (Static IP / PPPoE / DHCP), and key in the information needed.

Note: This camera doesn't support POE router or hub.

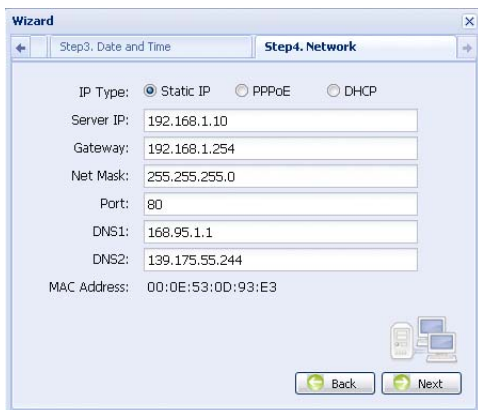

The screenshot shows the 'Step4: Network' configuration screen in a 'Wizard' window. It has radio buttons for 'IP Type' with 'Static IP' selected. Below are text input fields for 'Server IP' (192.168.1.10), 'Gateway' (192.168.1.254), 'Net Mask' (255.255.255.0), 'Port' (80), 'DNS1' (168.95.1.1), and 'DNS2' (139.175.55.244). A 'MAC Address' field shows '00:0E:53:0D:93:E3'. There is a network icon and 'Back' and 'Next' buttons at the bottom.

For Static IP:

- a) Enter the information of “Server IP”, “Gateway” and “Net Mask” obtained from your ISP (Internet Service Provider).
- b) Enter the port number. The valid number ranges from 1 to 9999. The default value is 80. Typically, the TCP port used by HTTP is 80. However in some cases, it is better to change this port number for added flexibility or security.

For PPPOE:

- a) Enter the user name and password obtained from your ISP.
- b) Continue the DDNS setting as instructed in “3.2.2 DDNS Setting” when you’re prompted to restart the web browser in Step8.

For DHCP:

- a) Before selecting this option, you need to finish the DHCP router settings first.
Get a router and connect it to the Internet via your PC (with Static IP or PPPoE setting). There are different setting methods for different routers. Please refer to their respective user manuals.
- b) Continue the DDNS setting as instructed in “3.2.2 DDNS Setting” when you’re prompted to restart the web browser in Step8.

Step7: In “Apply”, all the changes are listed. Check if the changes are correct.

- If yes, click “Save”.
- If no, click “Back” to where the changes should be made for modification, and click “Save” to apply the settings.

Note: You can also change the settings in the system configuration page via your web browser later. For details, please refer to “5. ACCESSING THE CAMERA VIA WEB BROWSER” in the user manual.



Step8: You will be prompted to restart your web browser for network setting changes.

- For PPPoE and DHCP, continue as instructed in “3.2.2 DDNS Setting”.
- For Static IP, disconnect your camera and your PC, and connect them to Internet separately. Next, enter the IP address of the camera in the URL address box of the web browser, and see if you can access the camera successfully.

3.2.2 DDNS Setting

Step1: Re-log in the network camera, and select “Close” for network environment checking.

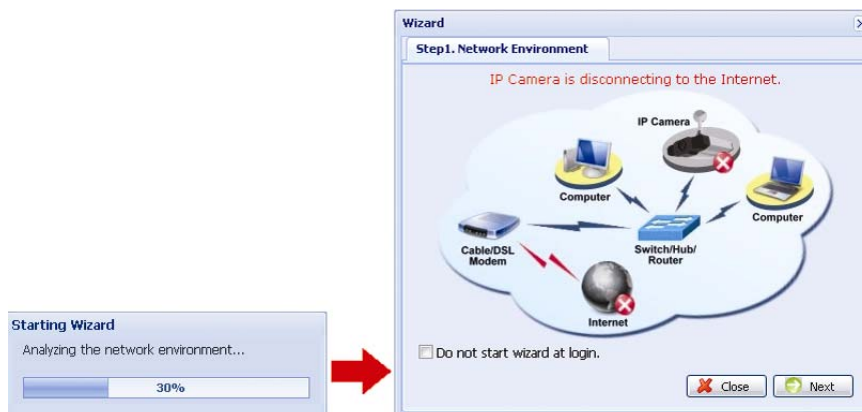

Step2: In the live page, click “Configuration” to open the configuration page.

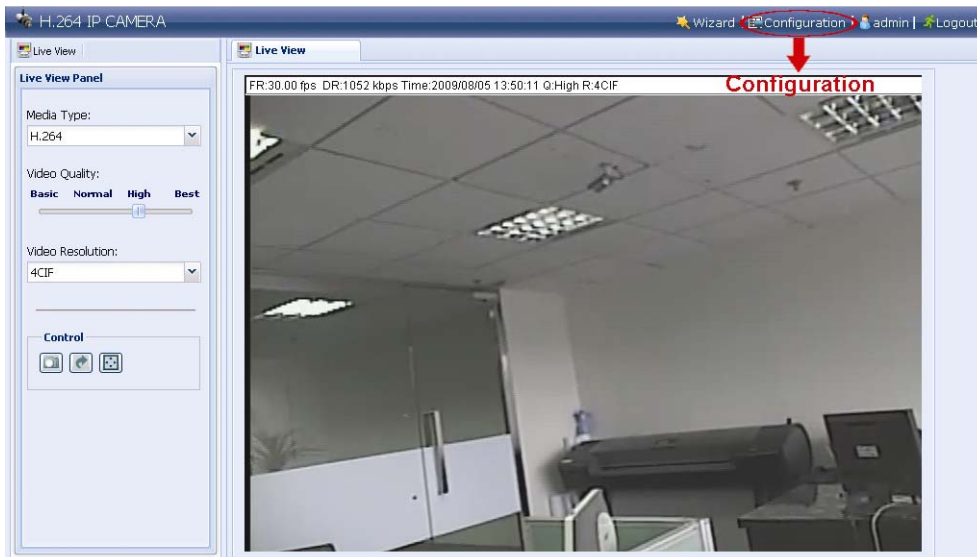

Step3: Click “Network” → “DDNS”, and check “DDNS Enable”.

Step4: Select “default” in “System Name”.

In “Hostname”, keep the default value, i.e. *the MAC address of this camera*, or change the name to a meaningful one. It’s easier to memorize.

Then, note down the whole address of the camera, for example, *MAC000E530D93E3.ddns.dvrtw.com.tw*.

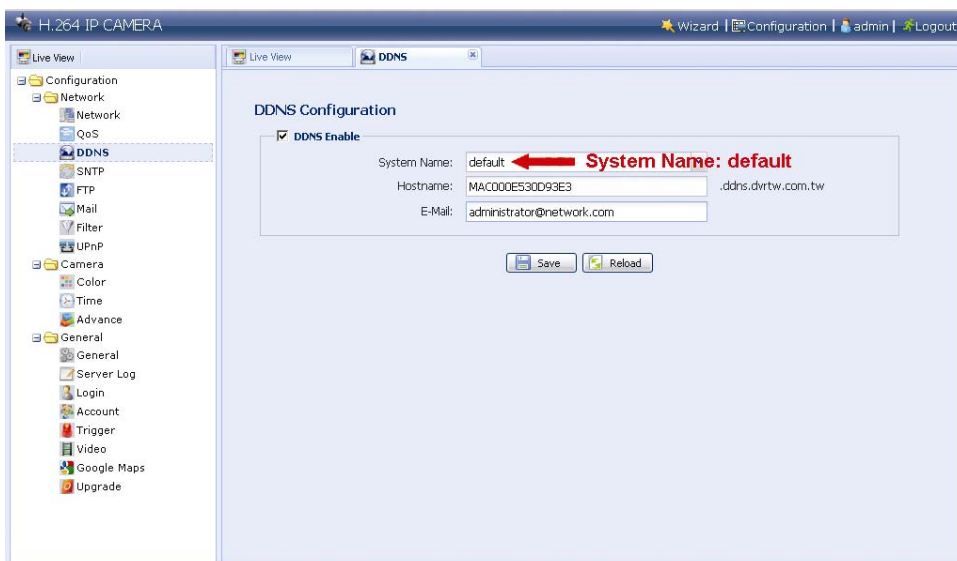

Note: You can also create a DDNS account from a website which provides free DDNS service. For details, please refer to “APPENDIX CREATING AN ACCOUNT FOR DDNS SERVICE” at page 18.

Step5: Click “Save” and log out. Then, disconnect your camera and your PC, and connect them to Internet separately.

Step6: Enter the host name you just note down in the URL address box of the web browser, and see if you can access the camera successfully.

3.3 Network Configurations via Video Viewer

3.3.1 Install the software

Step1: Place the supplied CD into your CD-ROM or DVD-ROM drive. The program will be automatically run.

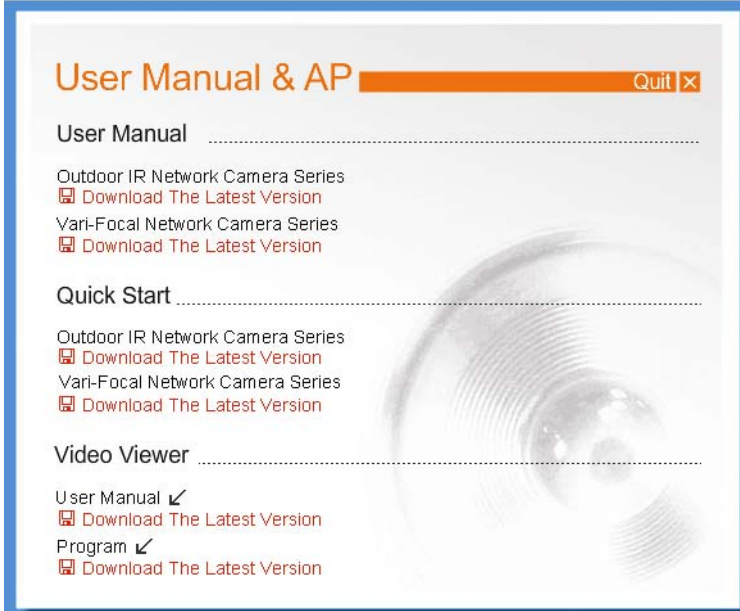



* The screen on the left side is an example only and may vary depending on the product you have.

Step2: Click “Program” in the “Video Viewer” section to install Video Viewer.

Step3: Follow the on-screen instructions to finish the installation. When the installation is completed, a shortcut icon  will be placed on your PC desktop.



Step3: Double-click  on your PC desktop to open Video Viewer and enter the control panel. By defaults, the “Address Book” panel will be displayed on the right side of the control panel.

Step4: Click  →  to key in the default IP address, user name, password, and port number of the camera you intend to connect.

The default values are as follows:

Item	Default Value
IP address	192.168.1.10
User name	admin
Password	admin
Port	80

OR

Click  →  to search the available IP address(es) of other camera(s) under the same domain as your PC's IP address. The found address(es) will be listed, and can be added into the address book by clicking .

Step5: Double-click the IP address you just added into the address book to log in.

3.3.2 Network Setting

Note: It's recommended to have the qualified installer to plan and configure the network setting.

Step1: Click “” to show the “General setting and utilities” dialog box, and click “Remote Config” twice to enter the camera setting page.

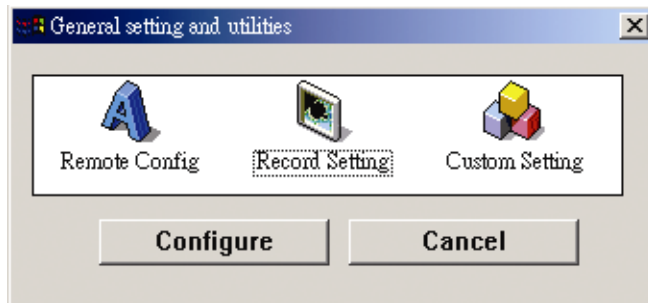

Step2: Select “Network” to make network settings **based on your network environment**. There are three network connection types: Static IP, PPPOE, and DHCP.

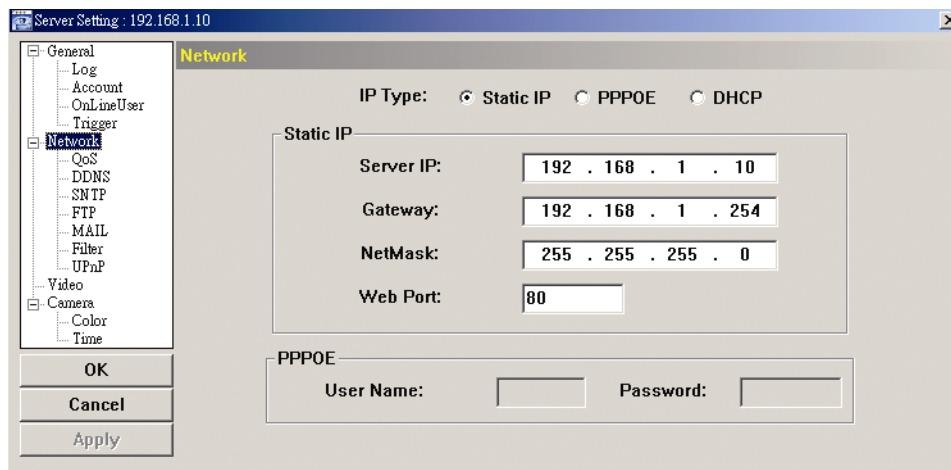

Note: This camera doesn't support POE router or hub.

For Static IP:

- Enter the information of “Server IP”, “Gateway” and “NetMask” obtained from your ISP (Internet Service Provider).
- Enter the port number. The valid number ranges from 1 to 9999. The default value is 80. Typically, the TCP port used by HTTP is 80. However in some cases, it is better to change this port number for added flexibility or security.
- Click “Apply”, and click “OK” to exit the setting page.

For PPPOE:

- Go to “Network” → “DDNS”, and select “default” in the “System Name” drop-down list.
- In “Hostname”, keep the default value, i.e. *the MAC address of this camera*, or change the name to a meaningful one. It's easier to memorize.
- Note down the whole address of the camera, for example, *MAC000E53114389.ddns.dvrtw.com.tw*.

Note: You can also create a DDNS account from a website which provides free DDNS service. For details, please refer to “APPENDIX CREATING AN ACCOUNT FOR DDNS SERVICE” at page 18.

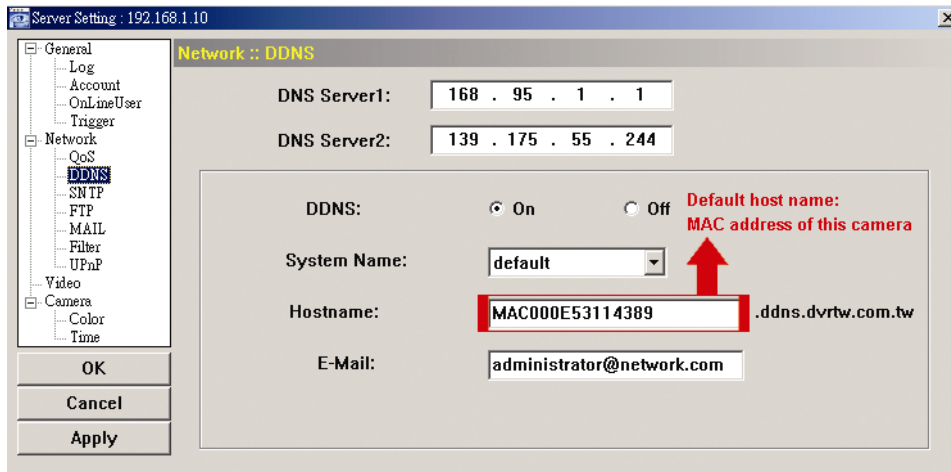

- f) Go to “Network” and select “PPPOE”. Then, enter the user name and password obtained from your ISP.

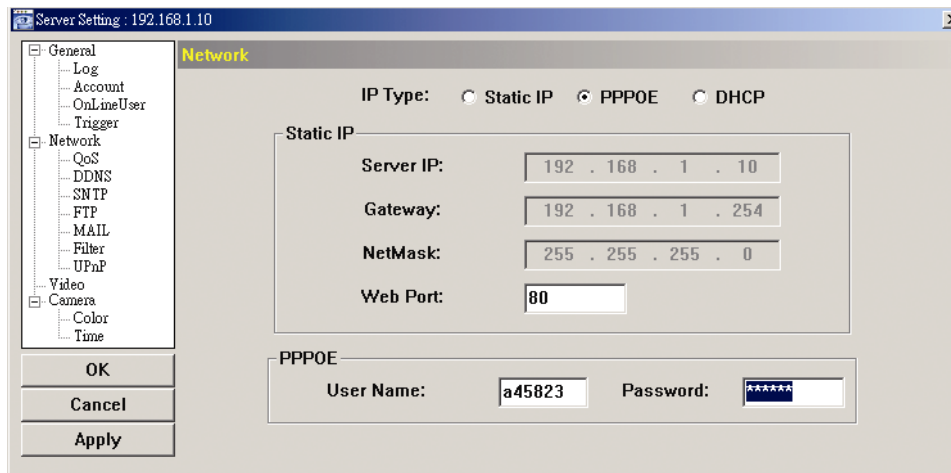

- g) Click “Apply”, and click “OK” to exit the setting page.

For DHCP:

- a) Finish the DHCP router setting.
Get a router and connect it to the Internet via your PC (with Static IP or PPPoE setting). There are different setting methods for different routers. Please refer to their respective user manuals.
- b) Go to “Network” → “DDNS”, and select “default” in the “System Name” drop-down list.
- c) In “Hostname”, keep the default value, i.e. *the MAC address of this camera*, or change the name to a meaningful one. It’s easier to memorize.
- d) Note down the whole address of the camera, for example, *MAC000E53114389.ddns.dvrtw.com.tw*.

Note: You can also create a DDNS account from a website which provides free DDNS service. For details, please refer to “APPENDIX CREATING AN ACCOUNT FOR DDNS SERVICE” at page 18.

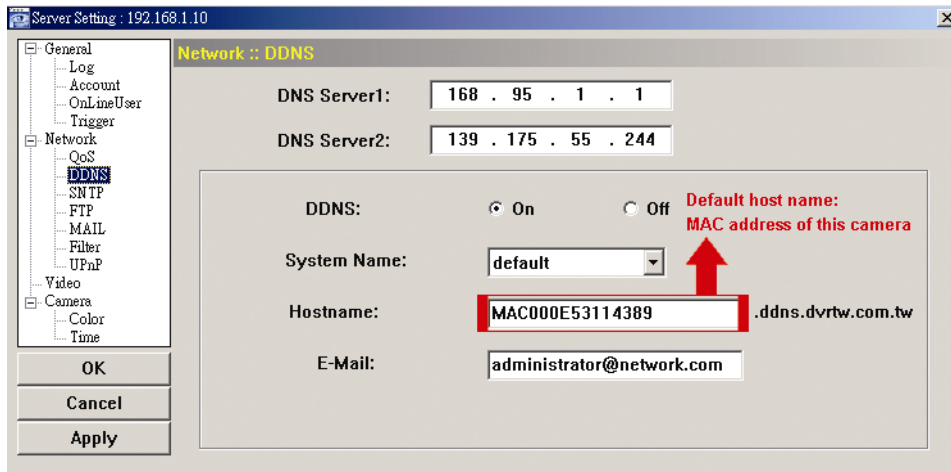

e) Go to “Network” and select “DHCP”.

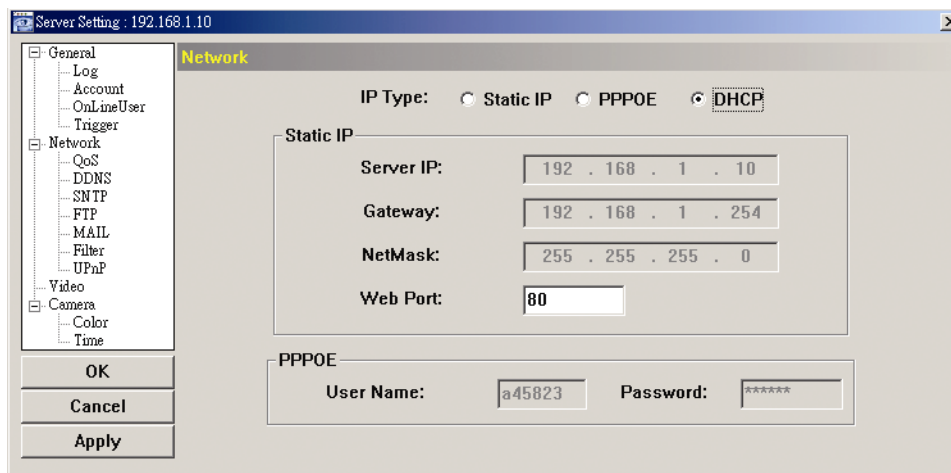

f) Click “Apply”, and click “OK” to exit the setting page.

Step3: Disconnect your camera and your PC, and connect them to Internet separately.

Step4: Add the IP address or host name of your camera in “

3.3.3 Change the password



It’s recommended to change the default password for the first time usage in case of any unauthorized access.

Step1: Click “

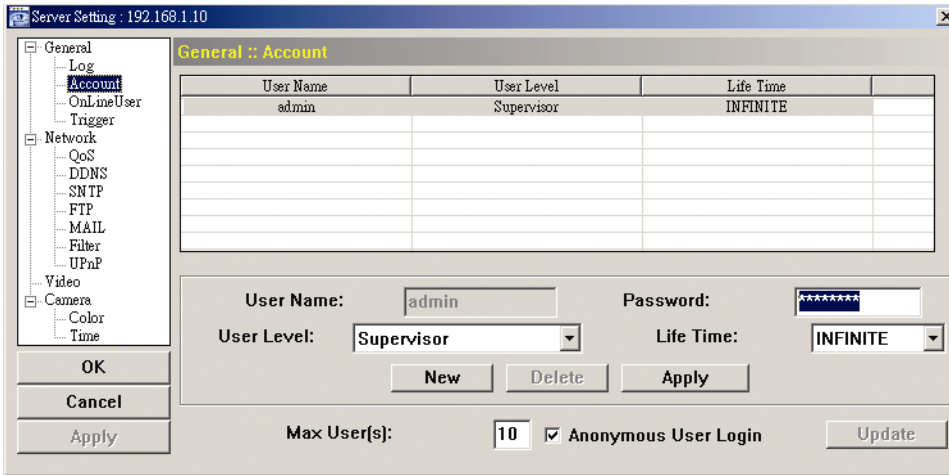
Step2: Click “General” → “Account”, and select the default account. Change the password directly, and click “Apply”.



Step3: Return to the live view, and click  to disconnect the camera.

Step4: Click  →  to select the IP address of the camera, and click  to enter the setting page and modify the password. Then, click “Login” to access the camera with the new password.

APPENDIX CREATING AN ACCOUNT FOR DDNS SERVICE

For PPPOE or DHCP, you should enter the host name which points to the IP address of your network camera for login first. Besides using the default DDNS service, you can also apply for new DNS services.

There are many websites for free DDNS service application, and below shows an example of DDNS account application from the website <http://www.dyndns.com>.

Step1: Go to <http://www.dyndns.com>, and click “Create Account” to sign up a DDNS account.

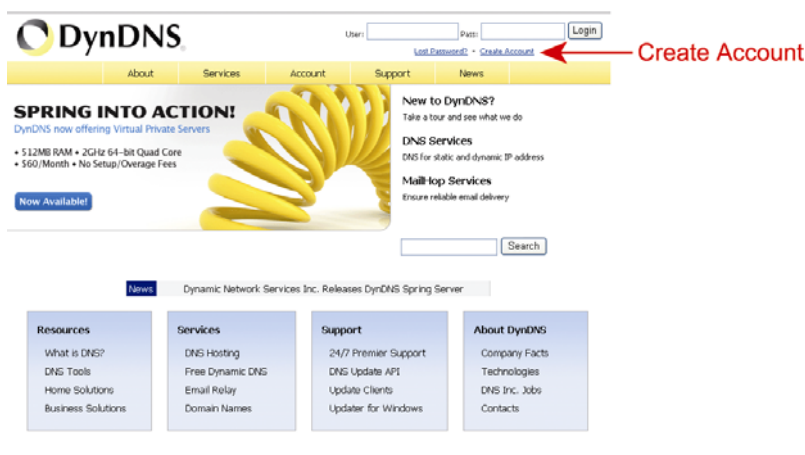

Step2: Enter all the information necessary for signing up an account according to the website instructions.

- Key in a user name for login, for example, *headoffice523*.
- Set the password and input it again to confirm.
- Key in your E-mail address and input it again to confirm.

Then, click “Create Account”.

Username: Password:

[Lost Password?](#) [Create Account](#)

My Account: [Create Account](#), [Login](#), [Lost Password?](#), [My Cart](#)

Search:

Create an account or log in to continue

Username:
 Password:
 Confirm password:
 Email:
 Confirm email:

Subscribe to: DynDNS.com newsletter (1 or 2 per month)
 Dyn inc. press releases
 Remove HTML formatting from email

Security Image:
 Enter the numbers from the above image:

I agree with the [acceptable use policy \(AUP\)](#) and [privacy policy](#).

← Create Account

If you're having difficulty creating your account, for any reason, feel free to [contact us](#).

Step3: The system will automatically send a confirmation email to your email account. Please read this email within 48 hours and complete the procedure to activate your account according to the instructions in the email. When the account is confirmed, you will see “Account Confirmed”. Your account is created successfully now.

Username: Password:

[Lost Password?](#) [Create Account](#)

My Account: [Create Account](#), [Login](#), [Lost Password?](#), [My Cart](#)

Search:

Account Confirmed

The account headoffice523 has been confirmed. You can now [login](#) and start using your account.

Getting Started

- [Create a dynamic DNS host with your own domain name](#)
- [Create a dynamic DNS host within our Free domains](#)
- [Setup email services](#)
- [Register a domain name](#)

Step4: Click “login”, and enter the user name and password you preset before to log in.
 Step5: Click “Add Host Services”.

Logged In User: headoffice523
[My Cart](#) [My Services](#) [Log Out](#)

My Account: [Create Account](#), [Login](#), [Lost Password?](#), [My Cart](#)

Search:

DynDNS Account headoffice523

<p>My Services</p> <p>View, modify, purchase, and delete your services.</p> <p>My Zones/Domains</p> <p>add Zone/Domain Services</p> <p>My Hosts</p> <p>add Host Services</p> <p>Dynamic DNS Pro</p> <p>Spring Server VPS</p> <p>Network Monitoring</p> <p>SSL Certificates</p> <p>Recursive DNS</p> <p>Support</p>	<p>Billing</p> <p>Update your billing information, complete a purchase, and view invoices.</p> <p>View Shopping Cart</p> <p>Active Services</p> <p>Order History</p> <p>Billing Profile and Vouchers</p> <p>Renew Services</p> <p>Auto Renew Settings</p> <p>Srv. Expirations</p>	<p>Account Settings</p> <p>Update your email address, set preferences, and delete your account.</p> <p>Change Email Address</p> <p>Change Password</p> <p>Change Username</p> <p>Contact Manager</p> <p>Mailing Lists</p> <p>Move Services</p> <p>Preferences</p> <p>Close Account</p>
---	--	---

Add Host Services

- Input a meaningful host name.
- Choose a host name.
- Enter the IP address you want to redirect.

Note down the whole host name, for example, *headoffice523.dyndns.org*. Then, click “Add To Cart” for billing.

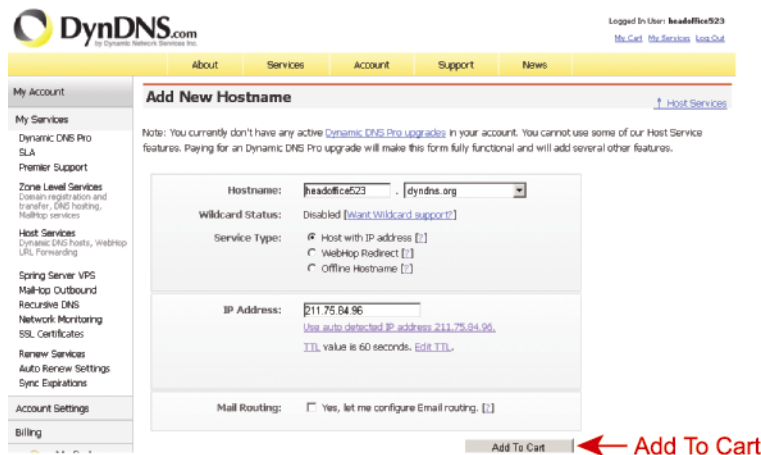

Note: This service is free. Just finish the billing process, and **NO** paying information is required.

Step6: Click “Activate Services” after checkout, and you’re ready to use DDNS services now.

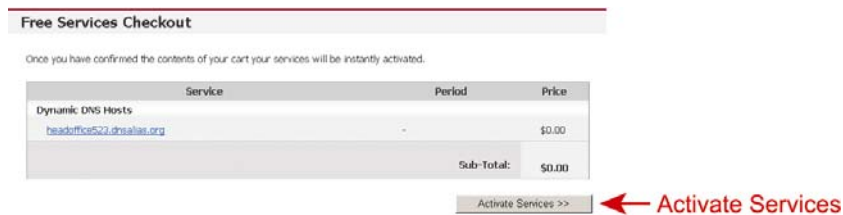

Step7: Return to Video Viewer, and go to “Network” → “DDNS”.

- Select “On” for DDNS.
- Select the system name you set when subscribing the DDNS service from the drop-down list, for example, *dyndns*.
- Enter the user name & password you used to log into the DDNS service.
- Enter the host name you set when subscribing the DDNS service, for example, *headoffice523*.

