



**Digitus**

**DN-13007/DN-13008/DN-13018**

**USB 2.0 Hi-Speed-Port MFP Server  
User's Manual**

**Version 2.24**

# Table of Contents

<b>CHAPTER1</b>	<b>INTRODUCTION .....</b>	<b>5</b>
1.1	<i>About 3 Models Described in this Manual .....</i>	5
1.2	<i>Customer Support.....</i>	5
<b>CHAPTER2</b>	<b>PRODUCT OVERVIEW .....</b>	<b>6</b>
2.1	<i>Package Contents .....</i>	6
2.2	<i>Product CD.....</i>	6
2.2.1	<i>Start-up Procedures .....</i>	6
2.3	<i>Physical Description.....</i>	6
2.4	<i>Installation Procedures.....</i>	7
2.4.1	<i>Installation and Integration.....</i>	7
2.4.2	<i>Configuration and Management.....</i>	7
2.5	<i>Features and Benefits .....</i>	7
<b>CHAPTER3</b>	<b>BASIC INSTALLATION .....</b>	<b>9</b>
3.1	<i>Connecting the Hardware.....</i>	9
3.2	<i>Wireless connection .....</i>	9
3.2.1	<i>Preliminary .....</i>	9
3.2.2	<i>Set Wireless Configuration Using MFP Server Control Center .....</i>	9
3.2.3	<i>Set Wireless Configuration Using Server's Web Pages .....</i>	12
3.3	<i>Assigning an IP Address to the Server.....</i>	16
3.3.1	<i>Preliminary .....</i>	16
3.3.2	<i>Ethernet Address.....</i>	16
3.3.3	<i>IP Address.....</i>	16
3.3.4	<i>Methods for Setting the IP Address.....</i>	16
3.3.5	<i>Server Names and Server Name Rules .....</i>	17
3.3.6	<i>Setting the IP Address Using DHCP.....</i>	17
3.3.7	<i>Setting the IP Address Using the Control Center .....</i>	17
3.3.8	<i>Setting the IP Address Using the Server's Web Pages .....</i>	19
3.4	<i>Name of USB Device .....</i>	21
3.4.1	<i>Printer Names.....</i>	21
3.4.2	<i>Storage Names .....</i>	21
<b>CHAPTER4</b>	<b>PRINT SERVER IN WINDOWS.....</b>	<b>22</b>
4.1	<i>Overview of Installation Methods.....</i>	22
4.2	<i>Connecting the Server.....</i>	22
4.2.1	<i>The Server and Windows PC on Same LAN .....</i>	23
4.2.2	<i>The Server and Windows PC on Different LANs .....</i>	23
4.3	<i>Setting up Local Windows Printer Driver.....</i>	23
4.4	<i>Adding Network Printers in Windows.....</i>	24
4.4.1	<i>Using Standard Windows Methods for LPR Printing Protocol .....</i>	24
4.4.2	<i>Using the Control Center for LPR Printing.....</i>	28
4.4.3	<i>Using Standard Windows Method for Raw TCP Printing .....</i>	29
4.4.4	<i>Using the Control Center for Raw TCP/JetDirect Printing .....</i>	31
4.4.5	<i>Using Standard Windows Methods for SMB/CIFS Printing.....</i>	32
4.4.6	<i>Using the Control Center for SMB/CIFS Printing .....</i>	33
4.4.7	<i>Using Standard Windows Method for IPP Printing.....</i>	35
<b>CHAPTER5</b>	<b>PRINT SERVER IN UNIX/LINUX .....</b>	<b>37</b>

5.1	<i>Configuring Host File</i> .....	37
5.2	<i>Printing by LPD/LPR</i> .....	37
5.3	<i>Using the Server on BSD UNIX/Linux</i> .....	37
5.4	<i>Using the Server on RedHat Linux (Fedora Core)</i> .....	38
<b>CHAPTER6</b>	<b>FILE SERVER</b> .....	<b>45</b>
6.1	<i>Preliminary</i> .....	45
6.2	<i>Storage Names</i> .....	45
6.3	<i>Connecting USB Mass Storage to the Server</i> .....	45
6.4	<i>Supported Codepages</i> .....	46
6.5	<i>Adding Your USB Mass Storages to Network with Security</i> .....	48
6.5.1	<i>Setting up File Server Using the Control Center</i> .....	48
6.5.2	<i>Setting up File Server Using Web Pages</i> .....	50
6.5.3	<i>Using Shared Storages by SMB/CIFS Method for Windows</i> .....	51
6.5.4	<i>Using Shared Storage by FTP Methods for Windows</i> .....	52
<b>CHAPTER7</b>	<b>THE NETUSB TECHNOLOGY</b> .....	<b>54</b>
7.1	<i>Introduction</i> .....	54
7.2	<i>Connect &amp; Disconnect</i> .....	54
7.3	<i>How to Use</i> .....	55
7.3.1	<i>Remote Installation</i> .....	55
7.3.2	<i>NetUSB Printing</i> .....	57
7.3.3	<i>NetUSB Scanning</i> .....	59
7.3.4	<i>NetUSB Scanning using Auto-Connect Scan</i> .....	60
7.3.5	<i>Accessing USB Storage using NetUSB Technology</i> .....	62
7.4	<i>Limitations</i> .....	63
<b>CHAPTER8</b>	<b>THE CONTROL CENTER</b> .....	<b>64</b>
8.1	<i>Installing Control Center</i> .....	64
8.2	<i>Using the Control Center</i> .....	64
8.2.1	<i>Using Tools of Control Center</i> .....	64
8.2.2	<i>Displaying Server Status</i> .....	65
8.2.3	<i>Setting up Server Configuration</i> .....	65
8.3	<i>Quitting the Control Center</i> .....	71
<b>CHAPTER9</b>	<b>THE SERVER'S WEB PAGES</b> .....	<b>72</b>
9.1	<i>Introduction</i> .....	72
9.2	<i>Using the Server's Web Pages</i> .....	72
9.2.1	<i>Displaying Server Status</i> .....	72
9.2.2	<i>Setting up Server Configuration</i> .....	73
<b>CHAPTER10</b>	<b>EMAIL ALERTING</b> .....	<b>79</b>
<b>CHAPTER11</b>	<b>SNMP</b> .....	<b>79</b>
<b>CHAPTER12</b>	<b>TROUBLESHOOTING</b> .....	<b>80</b>
12.1	<i>LED Indicators</i> .....	80
12.2	<i>Firewall</i> .....	80
<b>CHAPTER13</b>	<b>RESTORE FACTORY DEFAULTS</b> .....	<b>81</b>
13.1	<i>Using the Control Center</i> .....	81
13.2	<i>Using the Server's Web Pages</i> .....	81
13.3	<i>Using Init Button</i> .....	81
13.4	<i>Default Parameters List</i> .....	82

<b>CHAPTER14</b>	<b>UPGRADE FIRMWARE .....</b>	<b>84</b>
<b>CHAPTER15</b>	<b>THE INIT BUTTON .....</b>	<b>87</b>

# Chapter1 Introduction

Thank you for purchasing this Digitus DN-13007/DN-13008/DN-13018 USB MFP Server (in the following referred to as "Server"). This Server is designed to connect your AIO/MFPs (All-In-One/Multifunction Peripheral), printers, USB mass storages (hard drives, flash drives, and memory card readers), and scanners, to your network, allowing all network users access to these shared USB devices resources.

## 1.1 About 3 Models Described in this Manual

This manual provides introductory information as well as detailed instructions on how to set up and manage Digitus DN-13007/DN-13008/DN-13018 in various network environments. The following table shows the differences among the 3 models. All 3 models have a 10/100 Mbit/sec Lan port. However, DN-13008 has only one USB port, while both DN-13007 and DN-13018 have two USB ports. Compared with DN-13007, DN-13018 has an additional wireless module (802.11b/g). Except for the wireless configuration, most configuration and operations are the same for DN-13007 and DN-13018. Similarly, almost all of the configuration and operations are the same for DN-13007 and DN-13008 except that only one USB device can be connected to DN-13008 while at most two USB devices can be connected to DN-13007. Unless explicitly specified, all instructions in the manual apply to DN-13007 and DN-13008 and DN-13018.

Model	LAN	Wireless	USB Port(s)
DN-13008	Yes	No	1
DN-13007	Yes	No	2
DN-13018	Yes	Yes	2

To fully benefit from this document, you should be familiar with basic networking principles. The instructions described in this manual are based on the settings in a new Server. To reload the Factory Parameters, you can reset this Server back to Factory Default, which will restore most of the settings. For details, please refer to the chapter "Restore Factory Defaults".

## 1.2 Customer Support

Should you require any technical assistance, please contact your product reseller. Or you can visit our website at <http://www.digitus.info> for latest product information. This document is subject to changes without prior notice.

# Chapter2 Product Overview

## 2.1 Package Contents

Verify that nothing is missing from the package by using the checking list below. Please contact your dealer if anything is missing or damaged. All packing materials are recyclable. Please confirm the items in the package below:

- This Server (DN-13007 or DN-13008 or DN-13018)
- CD (Control Center and User's Manual and Quick Installation Guide)
- Power Adaptor

## 2.2 Product CD

This CD provides easy-to-use Control Center software, and the User's Manual and Quick Installation Guide.

### 2.2.1 Start-up Procedures

If your computer is configured to auto start CDs, this CD will start automatically when inserted. You can also navigate to the CD and start the autorun.exe file from within the Windows file manager.

## 2.3 Physical Description

1. **Power Adaptor Connector:** DC IN 12V/1A adaptor
2. **Init Button:** restore the parameters to the default values
3. **Ethernet Connector:** a twisted pair category 5 cable
4. **Wireless Station (only for DN-13018):** IEEE 802.11 b/g wireless station with antenna inside
5. **USB Host Ports:** USB 1.1/2.0 low, full, and Hi-Speed compliant
6. **Indicators**
  - *Power Indicator* is lit while power is applied. If it is not lit, or if it blinks, there is a problem with this Server or power adapter.
  - *Link Status* (only for DN-13007 and DN-13008) is lit while network is applied. If it is not lit, it indicates that this server does not connect to the network.
  - *Status Indicator* (only for DN-13007 and DN-13008) blinks to indicate network activity.
  - *LAN Indicator* (only for DN-13018) blinks to indicate wired network activity. If it is lit, it indicates the wired network is applied. If it is not lit, it indicates that the server does not connect to the wired network.
  - *WLAN Indicator* (only for DN-13018) blinks to indicate wireless network activity. If it is lit, it indicates the wireless network is applied. If it is not lit, it indicates that the server does not connect to the wireless network.
  - *USB1 Indicator* is lit while a USB device connects to USB1 Port of this Server. If it is not lit, or if it blinks, there is a problem with the USB device or this Server.
  - *USB2 Indicator* is lit while a USB device connects to USB2 Port of this Server. If it is not lit, or if it blinks, there is a problem with the USB device or this Server.

**Note:** There is only one USB LED indicator for DN-13008.

## 2.4 Installation Procedures

### 2.4.1 Installation and Integration

Please refer to the table below to select the appropriate installation method. The Control Center is available on the CD or from Digitus' website.

Function	OS	Method	Description
Print Server	Windows	Standard Windows Add Printer Wizard	Installation of LPR, Raw TCP (JetDirect), Local Port Using SMB, and IPP
		Control Center Tool	Installation of LPR, Raw TCP, Local Port Using SMB
	Apple MAC OS x	Printer Setup Tool	LPR, Raw TCP (JetDirect) SMB, IPP
	Unix/Linux	Edit /etc/printcap File	Using vi or other editors to edit the <i>printcap</i> file
RedHat Linux Printer System Manager		Using X-Windows Interface to operate	
File Server	Windows	None	Don't need installation
	Apple MAC OS X	None	
	Unix/Linux	Samba	Use smbclient in Samba
Scan Server	Windows XP, 2000, 2003 server	The Control Center	Installation of NetUSB driver

### 2.4.2 Configuration and Management

This Server can be configured and managed from its internal web pages or from the *Control Center*. These web pages or PC tools offer you a management tool suitable for all supported network environments.

## 2.5 Features and Benefits

This Server provides the following features and benefits:

1. **Reliability:** The Server provides high performance and reliability combined with low power consumption.
2. **Flexibility:** The Server supports print/File/Scan sharing in all major computer systems and environments.

3. **Easy to Install:** The Server installs, operates, and is managed in a reliable and easy fashion.
4. **Security:** You can assign administrator name and password to restrict login.
5. **Monitoring:** The Server's web pages and user software allow you to continuously monitor the status of connected USB devices.
6. **Future Proof:** The firmware stored in the Server's Flash memory can be upgraded over the network. This allows you to quickly update and enhance its operational features when new Server software becomes available.



# Chapter3 Basic Installation

## 3.1 Connecting the Hardware

1. Make sure that your USB devices are switched off and that the Server's Power Adapter is disconnected.
2. Connect the USB devices to the USB ports with the USB cables.
3. Connect the Server to the network with a twisted-pair category 5 cable, 10baseT or 100baseTX.
4. Turn on the USB devices and make sure it is ready for use.
5. Connect the Power Adapter to the Server. The power indicator will light up and USB1 and USB2 indicators will flash in turn. (For DN-13008, only USB1 indicator will flash.) When the Link indicator lights up, the Server is correctly connected to the network. When USB1 and USB2 indicators do not flash, the Server starts to work normally.

## 3.2 Wireless connection

This section only applies to DN-13018.

### 3.2.1 Preliminary

- Before you can access wireless network, wireless parameters should be set correctly. You **have to** setup the first wireless parameter set through LAN (wired) connection.
- Wireless access can be set as 1. Infrastructure (station) mode, which need an access point to route network messages, or 2. Ad-hoc mode, which connect nearby wireless PC/devices with the same SSID (Service Set ID).
- Wireless access can be secured by WEP64, WEP128, or WPA-PSK/TKIP.
- In infrastructure mode, if network administrator wants to change any security related parameters, DN-13018 **should be** changed first, and then access point. If parameters mismatch causes wireless access is not allowed, you **have to** modify those parameters through LAN connection.
- In infrastructure mode, the maximal transfer rate is 54 Mbits depending on access point's capability. In ad-hoc mode, only 802.11b (the maximal transfer rate is 11 Mbits) is allowed by specification.

### 3.2.2 Set Wireless Configuration Using MFP Server Control Center

1. Install MFP Server Control Center. MFP Server Control Center is available in the DN-13018 USB MFP Server Product CD.
2. Start MFP Server Control Center and Auto-searching MFP server window will appear.

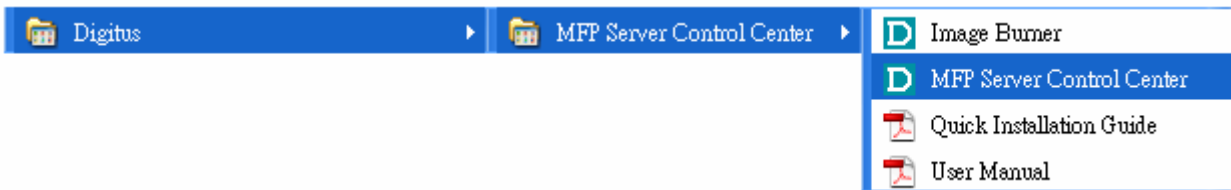

⦿ If the wireless parameters are not correct or not set yet, you have to use LAN to access MFP Server Control Center.

3. If the tool finds MFP servers in your local area network, then you have to select a MFP server from the server list.

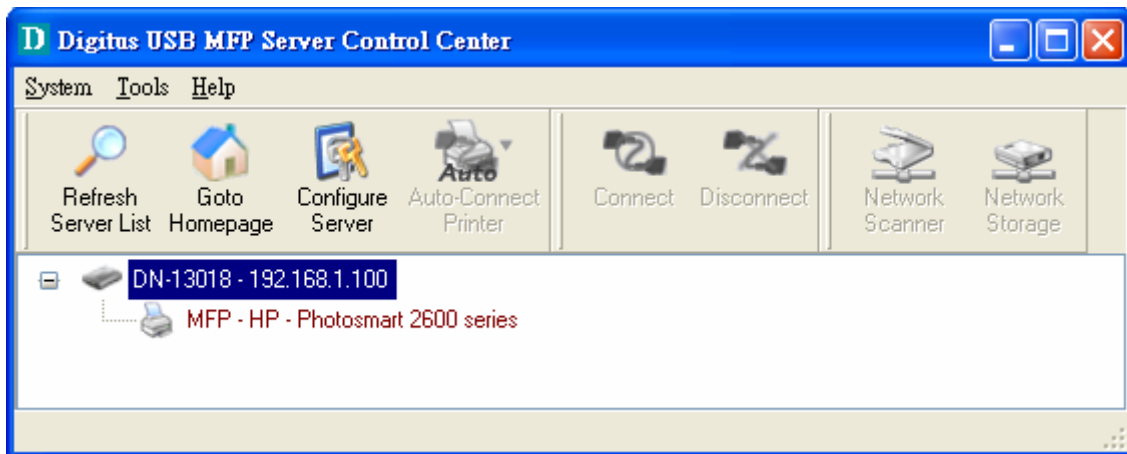

4. Double click the highlighted server (or click the "Configure MFP Server" button) and type the server's administrator (default: *admin*) and password (default: *admin*).

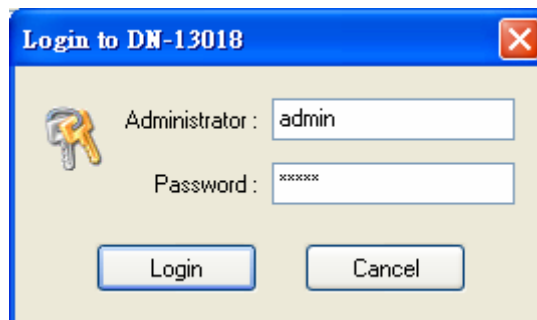

5. After you login successfully, from the Server menu, select wireless. The set Wireless dialog appears.
6. In order to join an existing wireless network, you have to set the correct network type (infrastructure or ad-hoc), SSID, and the correct security method with the correct key information.
7. If the wireless network is secured by WEP64 or WEP128, authentication method, key index, and WEP key must be set correctly.

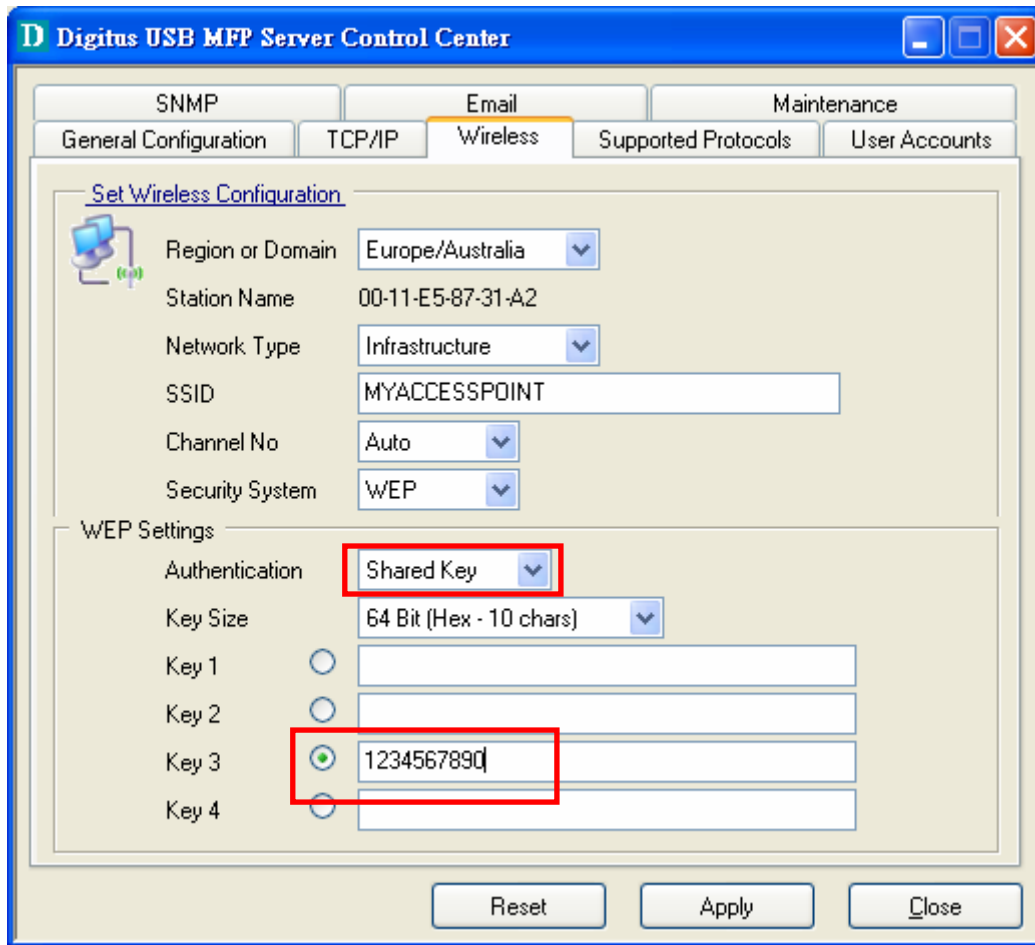

8. If the wireless network is secured by WPA-PSK/TKIP, the shared key must be set correctly.

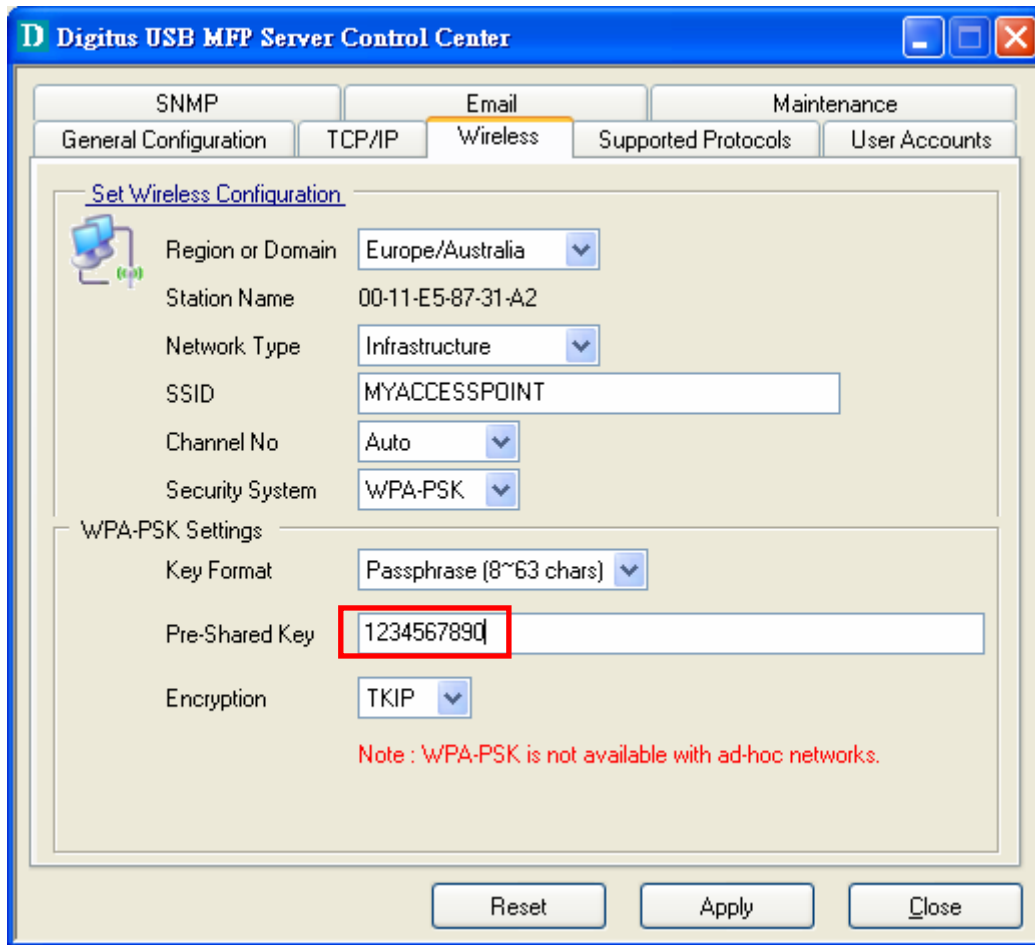

9. Click **Apply** to save your settings. And the server will reboot.
10. You have now finished the procedure of setting the wireless parameters.

- ⊗ In infrastructure mode, DN-13018 searches all channels to join the matched wireless service set. In ad-hoc mode, DN-13018 searches all channels to join the matched wireless ad-hoc service set too, however, if none are found, DN-13018 creates that service set in the assigned channel.
- ⊗ In ad-hoc mode, WPA-PSK/TKIP is not allowed.

### 3.2.3 Set Wireless Configuration Using Server's Web Pages

1. You can see the IP address of MFP server in the server list. Open IE Browser and type server's IP address or click the Home Icon of MFP Server Control Center.

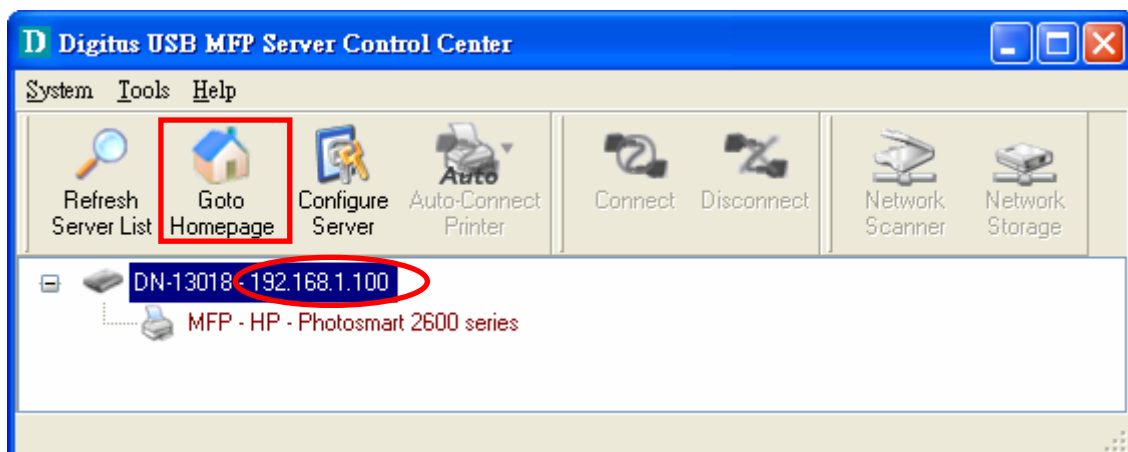

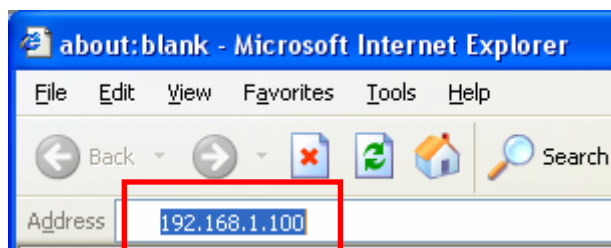

- ⌘ If the wireless parameters are not correct or not set yet, you have to use LAN to access Web Pages.
  - ⌘ If the TCP/IP parameters of DN-13018 are not correct, you have to use MFP Server Control Center to set the TCP/IP parameters first.
2. Go to the web page and click **CONFIG** icon.



Welcome to the Digitus USB MFP Server web configuration.

- Click **STATUS** to show your system status.
- Click **CONFIG** to adjust each setting of the device.
- Click **CONTACT US** to view the company info.

3. Login your administrator (default: *admin*) and password (default: *admin*).

### Login to Digitus MFP Server

Administrator	<input type="text" value="admin"/>
Password	<input type="password" value="*****"/>
<input type="button" value="Login"/> <input type="button" value="Cancel"/>	

4. Click **Wireless** icon.

The screenshot shows the DIGITUS CONFIG web interface. At the top, there is a navigation bar with links for HOME, STATUS, CONFIG, and CONTACT US. Below this, the word 'CONFIG' is displayed in a large font. On the left side, there is a sidebar menu with the following options: General Configuration, TCP/IP, Wireless (highlighted with a dotted border), Supported Protocols, User Accounts, SNMP, Email, Restart Server, and Maintenance. The main content area is titled 'Set Wireless Configuration' and is divided into two sections: 'Basic' and 'Security'. The 'Basic' section contains the following fields: Region or Domain (dropdown menu set to Europe/Australia), Station Name (text input field containing 00-11-E5-87-31-A2), Network Type (dropdown menu set to Infrastructure), SSID (empty text input field), and Channel No (dropdown menu set to Auto). The 'Security' section contains the Security System (dropdown menu set to Disable). At the bottom of the configuration area, there are two buttons: Submit and Reset.

5. In order to join an existing wireless network, you have to set the correct network type (infrastructure or ad-hoc), SSID, and the correct security method with the correct key information.
6. If the wireless network is secured by WEP64 or WEP128, key index and WEP key must be set correctly.

## Set Wireless Configuration

Basic	
Region or Domain	Europe/Australia ▾
Station Name	00-11-E5-87-31-A2
Network Type	Infrastructure ▾
SSID	MYACCESSPOINT
Channel No	Auto ▾
Security	
Security System	WEP ▾
WEP Settings	Authentication Shared Key ▾
	Key Size 64 Bit (Hex - 10 chars) ▾
	Key 1 <input type="radio"/> <input type="text"/>
	Key 2 <input type="radio"/> <input type="text"/>
	Key 3 <input checked="" type="radio"/> 1234567890
	Key 4 <input type="radio"/> <input type="text"/>
<input type="button" value="Submit"/> <input type="button" value="Reset"/>	

7. If the wireless network is secured by WPA-PSK/TKIP, the shared key must be set correctly.

## Set Wireless Configuration

Basic	
Region or Domain	Europe/Australia ▾
Station Name	00-11-E5-87-31-A2
Network Type	Infrastructure ▾
SSID	MYACCESSPOINT
Channel No	Auto ▾
Security	
Security System	WPA - PSK ▾
WPA-PSK Settings	Key Format Passphrase (8~63 chars) ▾
	Pre-Shared Key 1234567890
	Encryption TKIP ▾
<i>Note: WPA-PSK is not available with ad-hoc networks.</i>	
<input type="button" value="Submit"/> <input type="button" value="Reset"/>	

8. Click **Submit** to save your settings. And the server will reboot.
9. You have now finished the procedure of setting the wireless parameters.

- ⌘ In infrastructure mode, DN-13018 searches all channels to join the matched wireless service set. In ad-hoc mode, DN-13018 searches all channels to join the matched wireless ad-hoc service set too, however, if none are found, DN-13018 creates that service set in the assigned channel.
- ⌘ In ad-hoc mode, WPA-PSK/TKIP is not allowed.

After properly configuring the wireless parameters, you can remove the network cable and reboot the DN-13018. DN-13018 will then connect to your wireless network. DN-13018 will detect if a network cable is plugged-in or not. If a network cable is plugged-in, DN-13018 will always connect to the network through the network cable. Otherwise it will always connect to the network through wireless module. Once DN-13018 connects to the network, either by network cable or by wireless module, all operations of print / scan / file server are exactly the same.

### **3.3 Assigning an IP Address to the Server**

#### **3.3.1 Preliminary**

- If you have a DHCP server on your network, your Server will receive an IP address automatically. The IP address will then appear on the *Control Center* or on the page of configuration report that you printed earlier. If your DHCP server does not give an IP address to the Server, the Server will use the Factory IP address: 192.168.1.100.
- If you are not working in a DHCP network, you need to manually set the Server's IP address.

#### **3.3.2 Ethernet Address**

You do not need to know the Ethernet address of your Server for assigning an IP address to it. The Control Center can automatically search Servers and list their Ethernet addresses. Besides, you can find Ethernet address that is located on the backside label of the Server.

#### **3.3.3 IP Address**

Unless you are assigning an IP address using DHCP, you must obtain an unused IP address from your network administrator.

#### **3.3.4 Methods for Setting the IP Address**

You can set the IP address of your Server using one of the following methods, depending on your network operating environment:

- Automatic IP Address Assignment
- Manual IP Address Assignment



### 3.3.5 Server Names and Server Name Rules

The default server name of the Server is “DN-13007” (for DN-13007) or “DN-13008” (for DN-13008) or “DN-13018” (for DN-13018). If you put two or more Servers in your local area network, to avoid using the same server names you have to change the server names by using the Control Center or the Server’s web pages. If your server name is longer than 15 characters, the Server uses only the first 15 characters.

### 3.3.6 Setting the IP Address Using DHCP

Follow the instructions below to get an IP address using DHCP:

1. Edit or create a scope in the DHCP manager of the DHCP daemon. The entries included in this scope should contain the following parameters:
  - range of IP addresses
  - subnet mask
  - default router IP address
  - DNS server IP address
  - lease duration
2. Activate the scope. The Server automatically gets the DHCP parameters. If you are using DNS, you may include at least one DNS server IP address in the DHCP scope or manually set the DNS server IP address using Server’s web pages or the Control Center.

### 3.3.7 Setting the IP Address Using the Control Center

11. Install the Control Center. The Control Center is available on the Product CD.
12. Start the Control Center and Auto-searching Server window will appear.

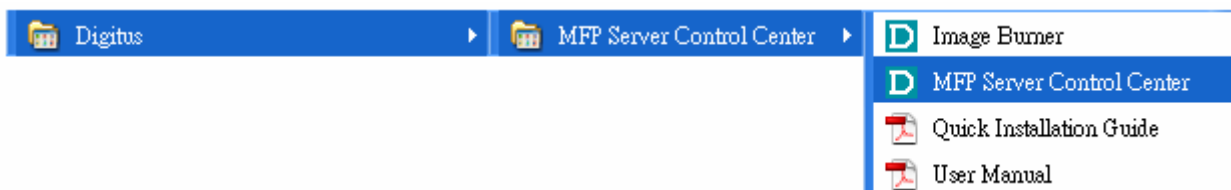

13. If the tool finds multiple Servers in your local area network, then you have to select one Server from the Server List.

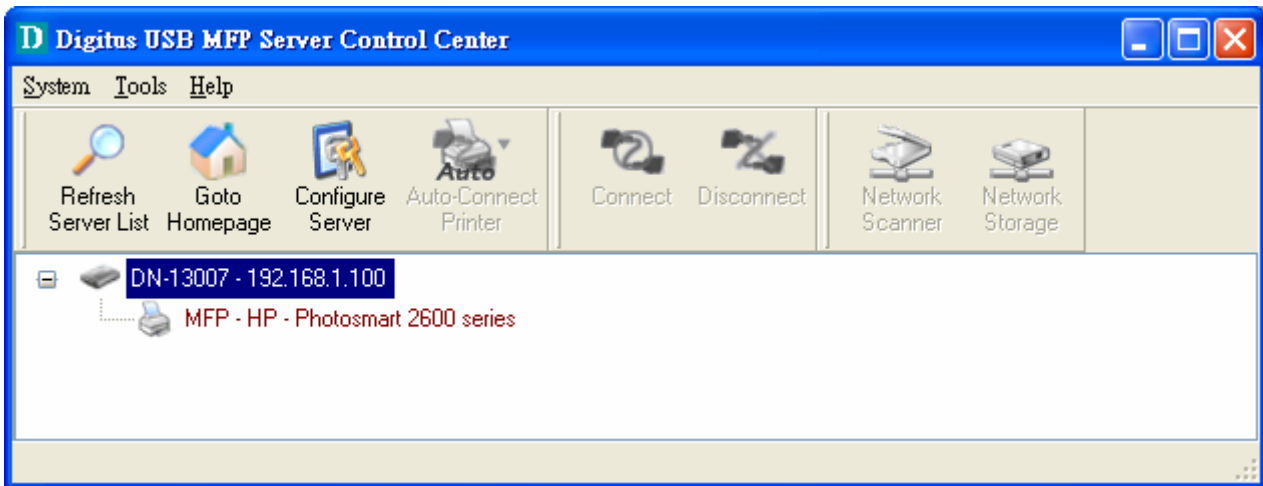

14. Double click the highlight list and enter the Server's administrator (default: *admin*) and password (default: *admin*).



15. After you have logged in successfully, select TCP/IP from the Server's menu. The Set IP Address dialog appears.

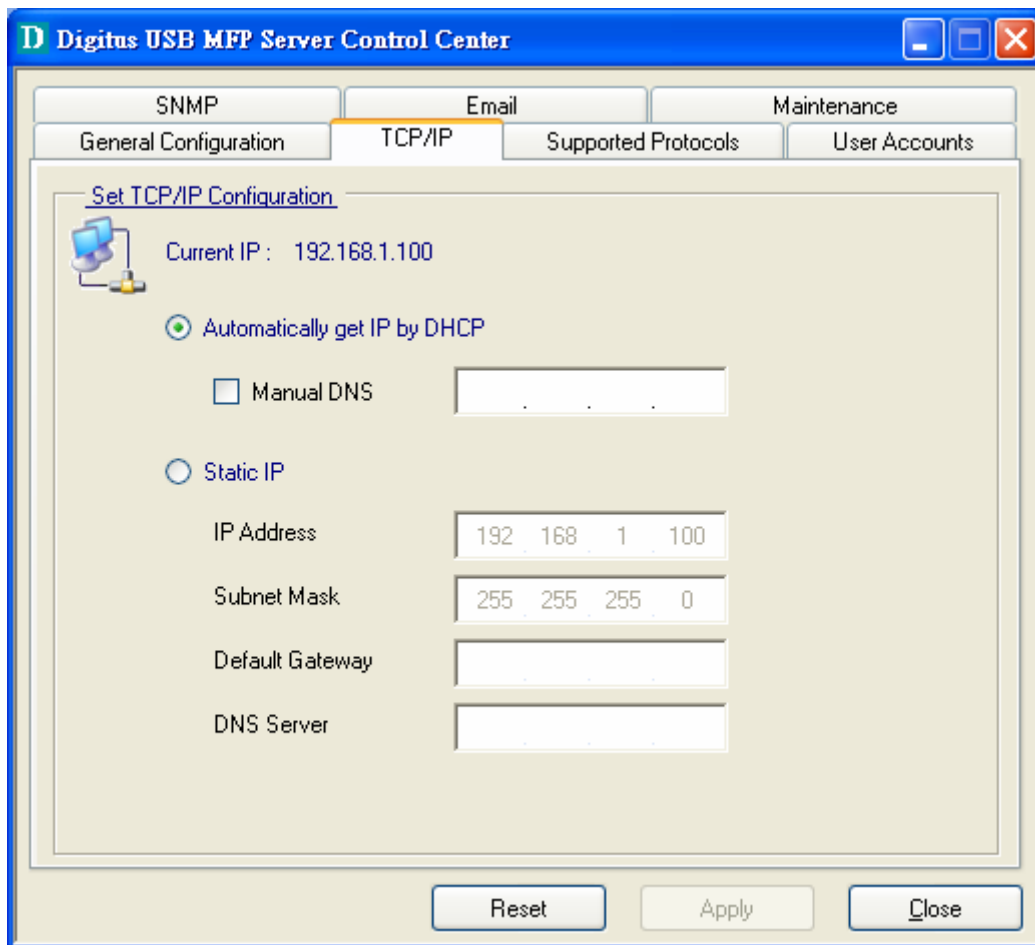

16. Click the button corresponding to your choice of IP setting method (static or dynamic using DHCP). When assigning a static IP address you also have to define Subnet Mask and Default Gateway. If you choose **Automatically get IP by DHCP**, you can use desired DNS by clicking the **Manual DNS** button and manually assigning a DNS.
17. Click **Apply** to save your settings. And the Server will reboot.
18. You have now finished the procedure of setting the IP address.

### 3.3.8 Setting the IP Address Using the Server's Web Pages

1. If you don't know the current IP of you Server, you have to do the Step1 ~ Step4 of Set the IP Address Using the Control Center.
2. You can see the IP address of you Server in the Server List. Open IE Browser and enter the Server's IP address or click the Home Icon of the Control Center.

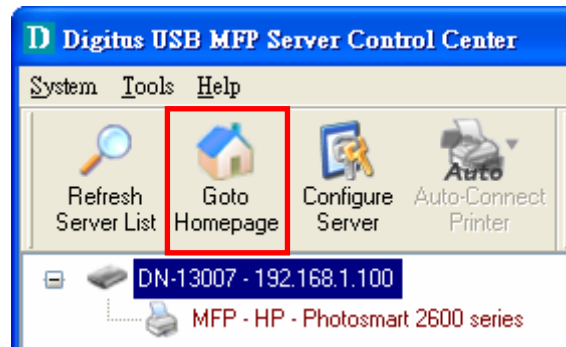

3. Go to the web page and click **CONFIG** icon.

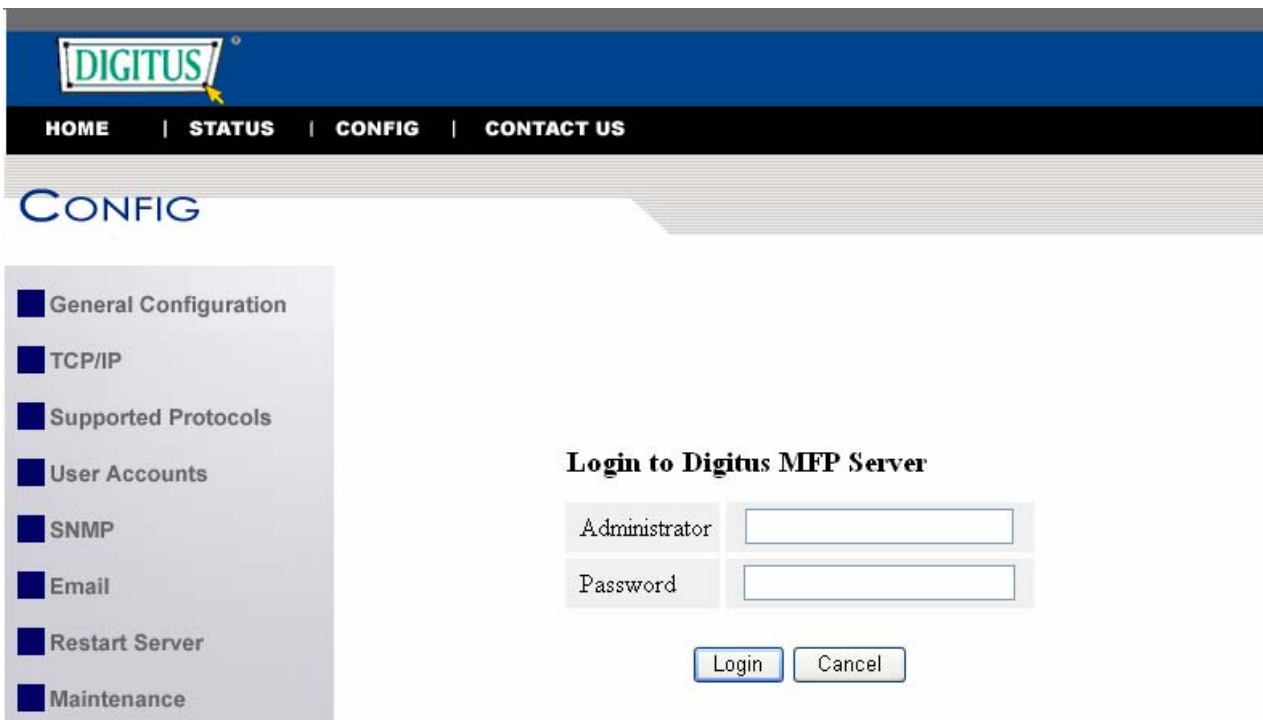

4. Enter administrator (default: *admin*) and password (default: *admin*).

5. Click **TCP/IP** icon.

6. Click the button corresponding to your choice of IP setting methods (static or dynamic using DHCP). When assigning a static IP address you also have to define Subnet Mask and Default Gateway.
7. Click **Submit** to save your settings. And the Server will reboot. You have now finished the procedure of setting the IP address.

### 3.4 Name of USB Device

#### 3.4.1 Printer Names

1. The system will set the printer model names as the default printer names. The system only allows a 12-character long USB device name. For example, the printer model name is "*LaserJet 3030 PCL 6*" and then the default printer name will be set as "*LaserJet 303*".
2. If system cannot get the printer model (For example, you use some parallel printers and use Parallel-to-USB cables to connect the printers), the default printer names are set as: *USB1\_Printer* and *USB2\_Printer* with respect to USB1 port and USB2 port.

#### 3.4.2 Storage Names

The local drives of the two storages in USB1 port and USB2 port are named as *USBx\_DyPz*, where *USBx* represents the *USBx* port, *Dy* represents the *y*-th Disk (in particular to card reader plugging in multiple cards) and *Pz* represents the *z*-th partition.

# Chapter4 Print Server in Windows

## 4.1 Overview of Installation Methods

This chapter describes how to add network printers.

**Table List for Installing Network Printer**

Windows Platform	Printing Protocols	Method
Windows 98, ME, 2000, XP and 2003	SMB/CIFS Printing	Standard Windows Add Printer Wizard
		The Control Center's Add Printer
Windows 2000, XP and 2003	IPP Printing	Standard Windows Add Printer Wizard
		The Control Center's Add Printer
	LPR Printing	Standard Windows Add Printer Wizard
		The Control Center's Add Printer
Raw TCP/JetDirect Printing	Standard Windows Add Printer Wizard	
	The Control Center's Add Printer	

### Steps for Installing Network Printer

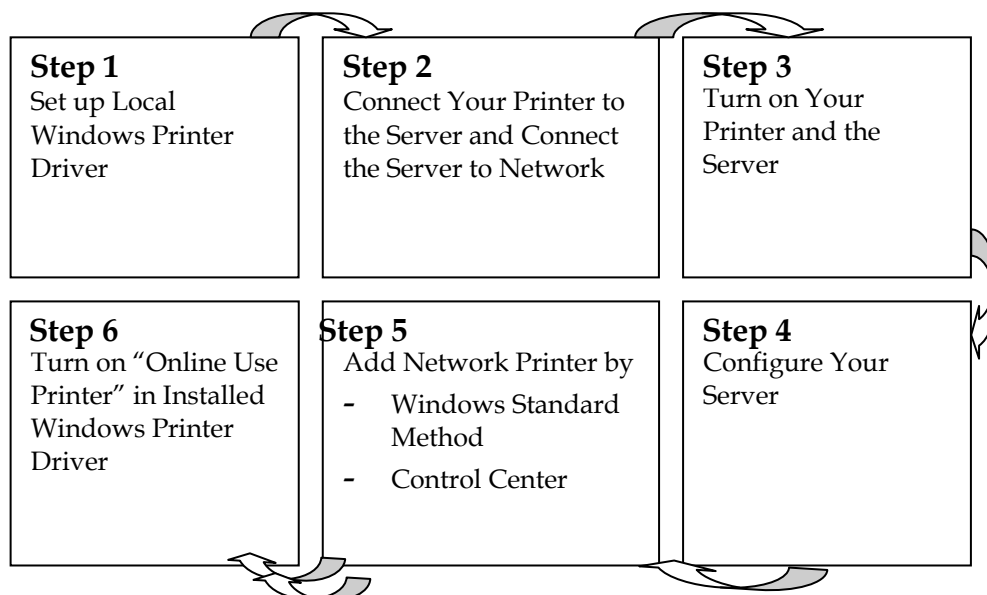

## 4.2 Connecting the Server

To configure your Server correctly, you should know which type of network topology that your Server is connecting to.

### 4.2.1 The Server and Windows PC on Same LAN

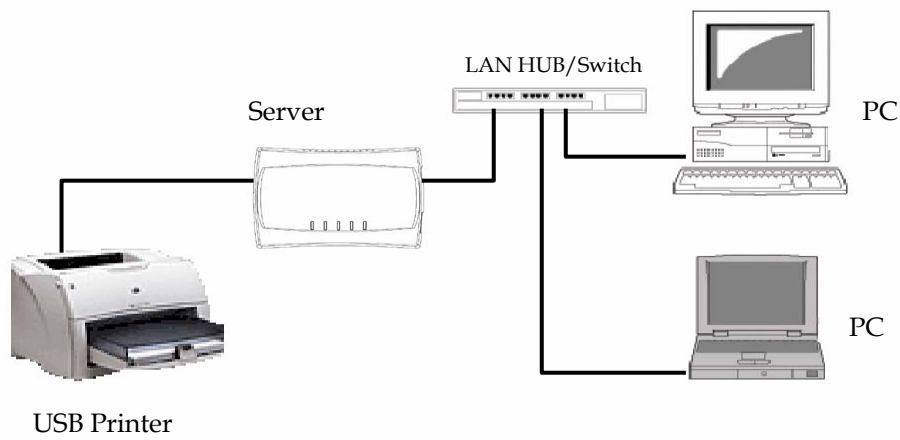

### 4.2.2 The Server and Windows PC on Different LANs Example: Wired Windows PC across Internet

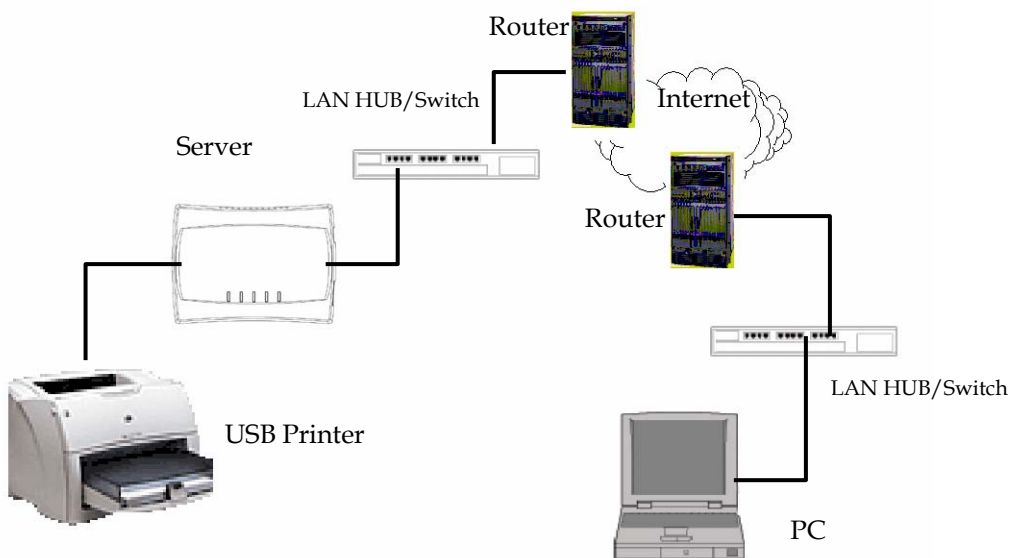

### 4.3 Setting up Local Windows Printer Driver

You are advised to install your Windows printer driver in advance. For most printers, you can install the printer drivers with the following procedure:

1. Click **Start**, click **Control Panel**, click **Printers and Other Hardware**, and then click **Printers and Faxes**.
2. Double click **Add Printer** to start the Add Printer Wizard, and then click **Next**.
3. Click **Local printer**, clear the **Automatically detect and install my Plug-n-Play printer** check box to avoid having to wait for the completion of another printer search, and then click **Next**. If you leave this option selected, Windows will attempt to find the printer itself and figure out what kind it is. If Windows does not find the printer, the wizard will continue as described in this task.
4. Select a Windows driver for your printer. Click **Next**.
5. Choose whether you want to share the printer with other network users. Do you want to print a test page? Select the appropriate radio button and click **Next** and **Finish**.

## 4.4 Adding Network Printers in Windows

Follow the instructions below to use the standard Windows Add Printer Wizard and the Control Center for adding a network printer in Windows 98 SE, ME, 2000, XP and 2003.

### **Note:**

1. Before adding a network printer, you are advised to install the local Windows printer driver in advance.
2. Before using network printer, you have to turn on "Use Printer Online" in installed network printer driver and then you can use the printer.

### 4.4.1 Using Standard Windows Methods for LPR Printing Protocol

**Windows Platform:** Windows 2000, XP and 2003

1. Open Printers and Faxes
2. Right-click the printer for which you want to change settings, and then click **Properties/ports**
3. Clear **Enable bidirectional support** and click **Add port**, and then click Standard TCP/IP Port from the dropdown and click **New port**.
4. The "**Add Standard TCP/IP Printer Port Wizard**" will pop up and click **Next**.



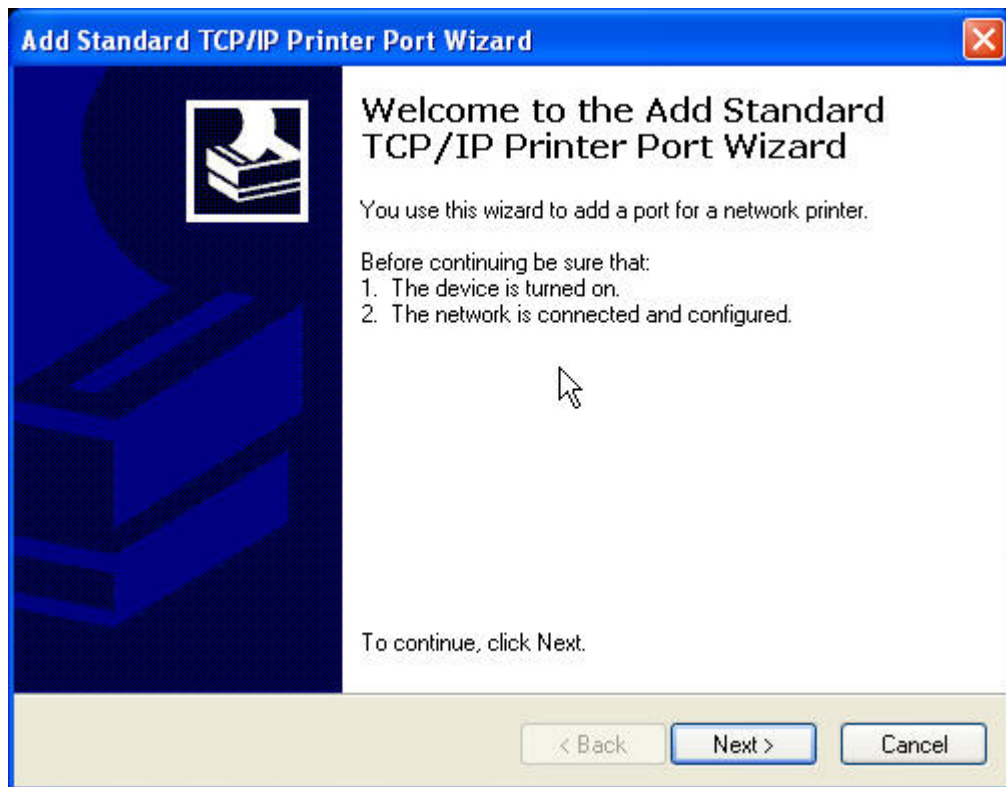

5. In the **Printer Name or IP Address** box, enter the Server Name of the Server or IP address of the Server. In the **Port Name** box, enter your desired names or **USB1\_LPR** or **USB2\_LPR** for printer connected to USB1 port and USB2 port, respectively.

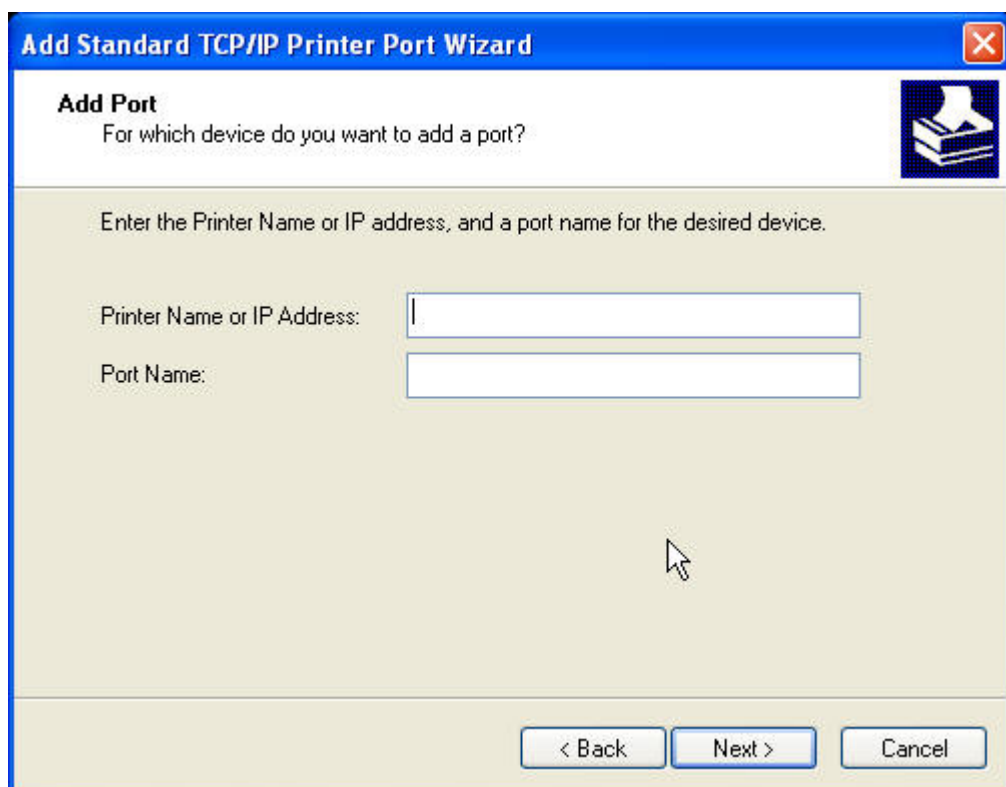

*☞ If your Server is running on a different LAN than your Windows PC such as Internet PC, you must enter Server's IP address in **Printer Name or IP***

**Address box.**

6. Click **Next**.

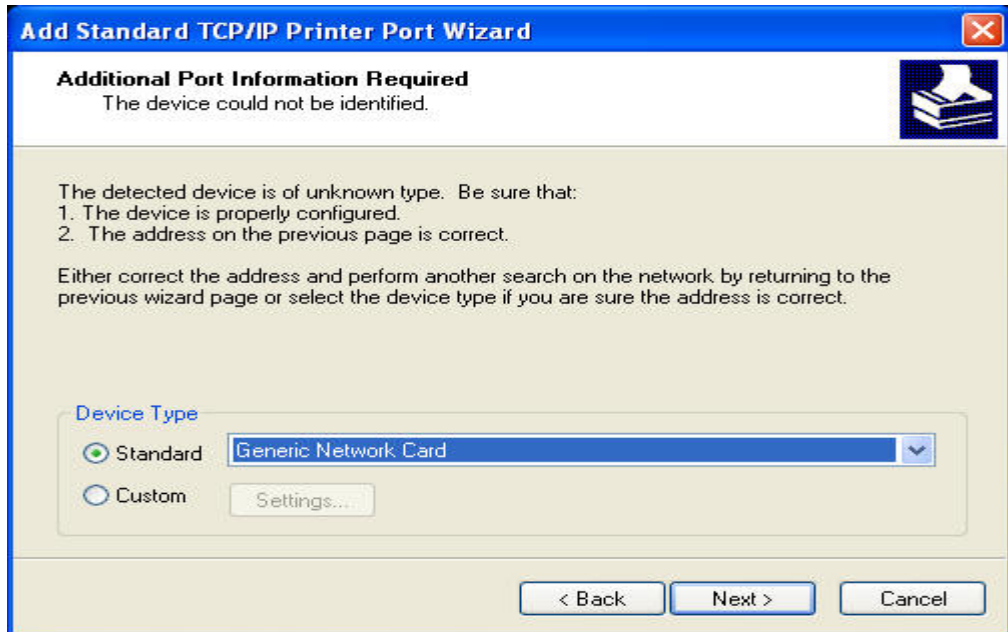

7. Click **Custom/settings**.

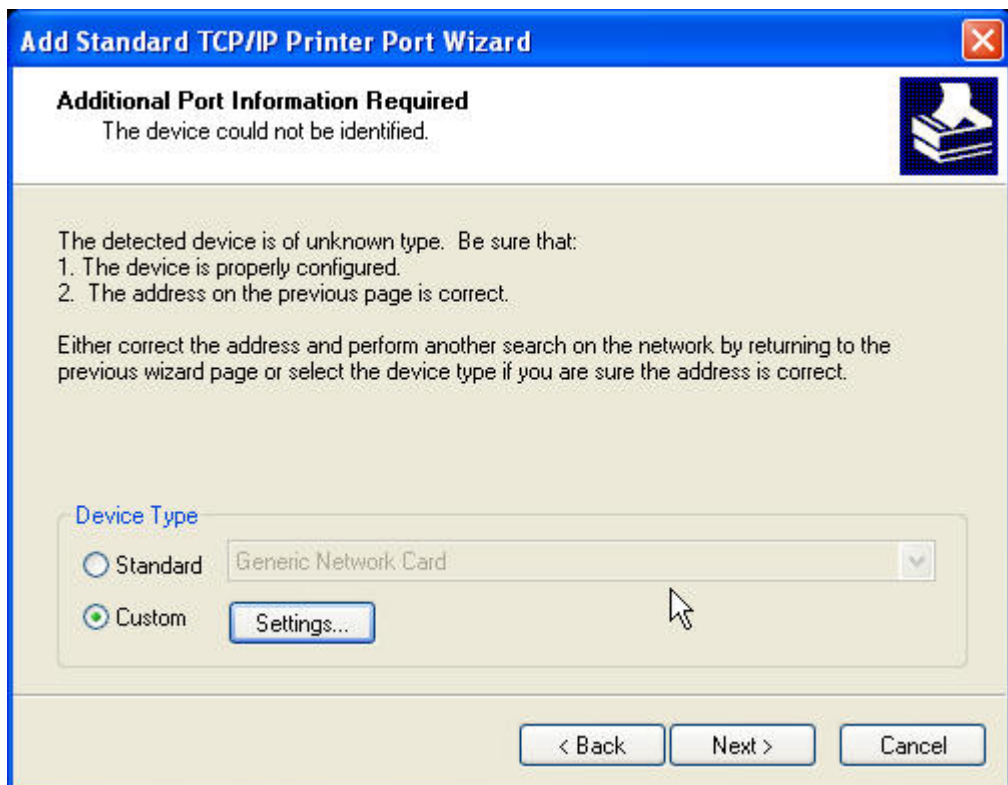

8. Click **Settings** and confirm that the settings are as below. The queue names are **USB1\_LQ**, **USB2\_LQ** for USB1 port 1 and USB2 port, respectively. Click **OK**.

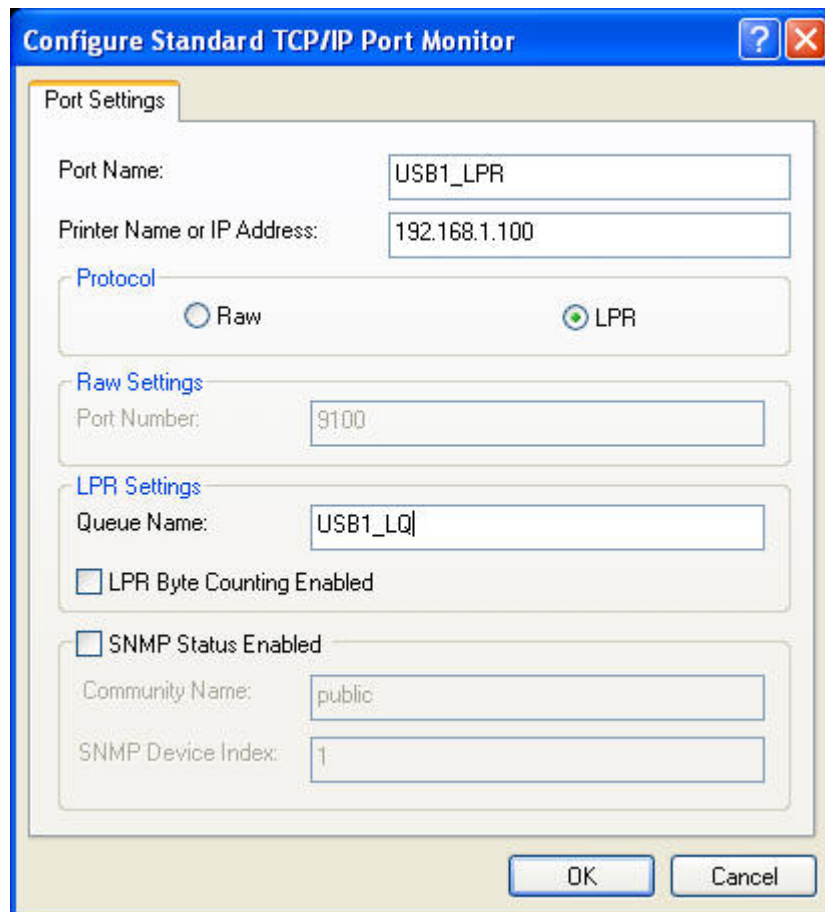

9. Click **Finish**

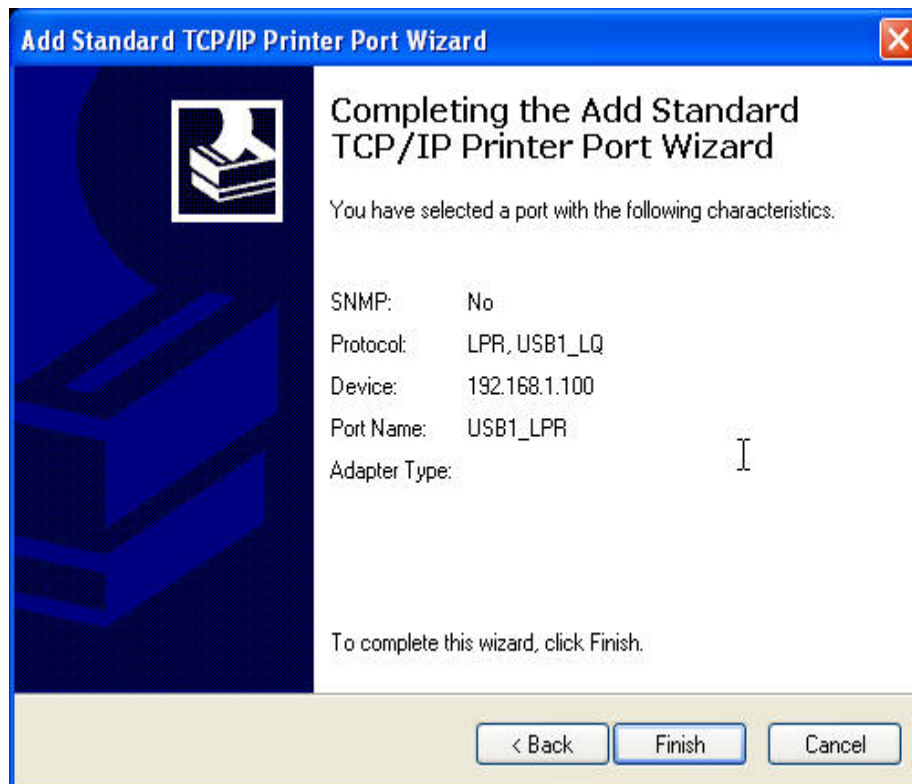

#### 4.4.2 Using the Control Center for LPR Printing

**Windows Platform:** Windows 2000, XP and 2003

1. Start the Control Center, right-click on your Server and select **Set Printer**.

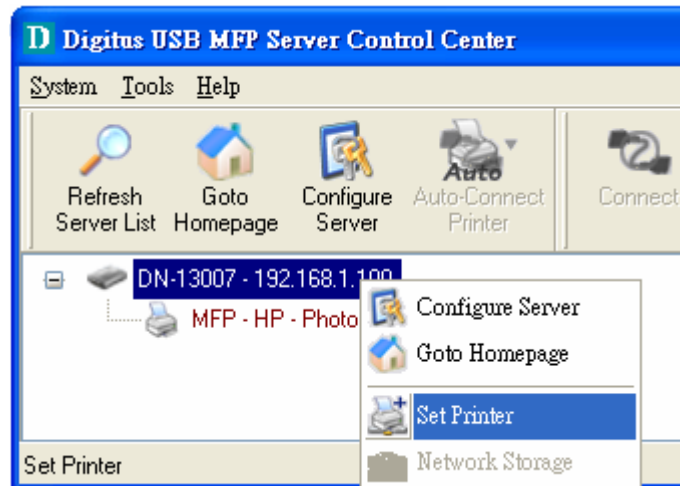

2. Select USB1 Port or USB2 Port to add the printer in **Set printer in** box, choose to use Server Name or IP address to represent the Server in **Select IP address or Host Name in printer port** box, and select the network printing protocol of **Printing with LPR (Line Printer Remote)**.

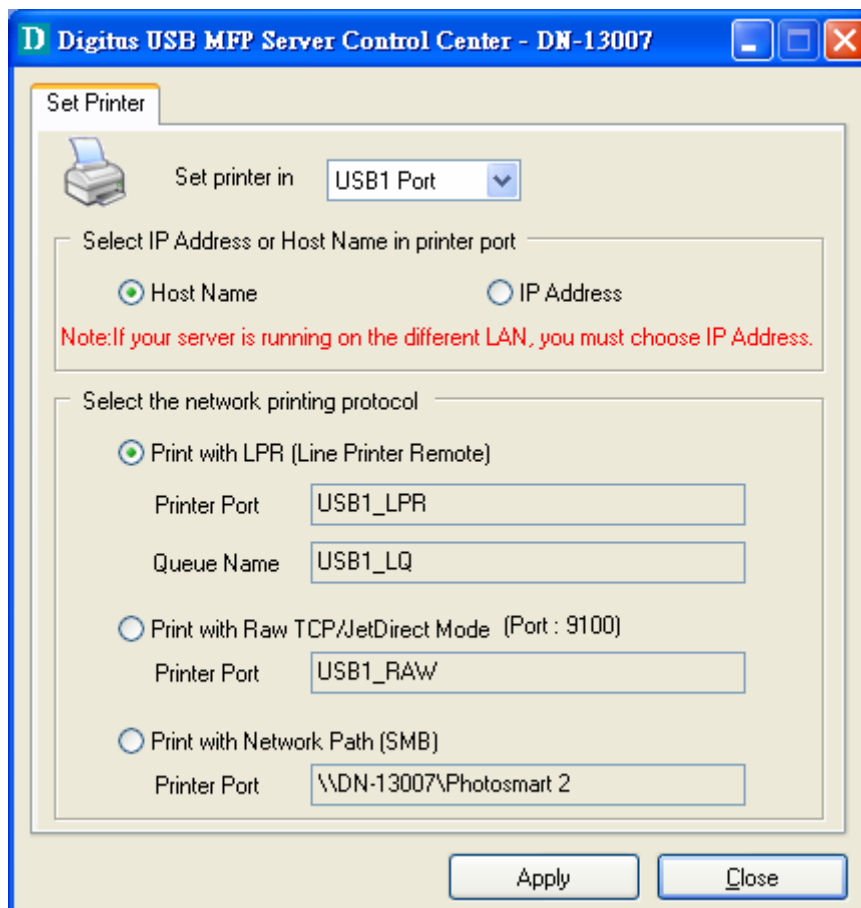

☞ If your Server is running on a different LAN than your Windows PC such as Internet PC, you must choose IP address in **Select IP address or Host Name in printer port** box.

3. Click **Apply**.
4. Select the desired printer driver and click **Set Port to Printer**.

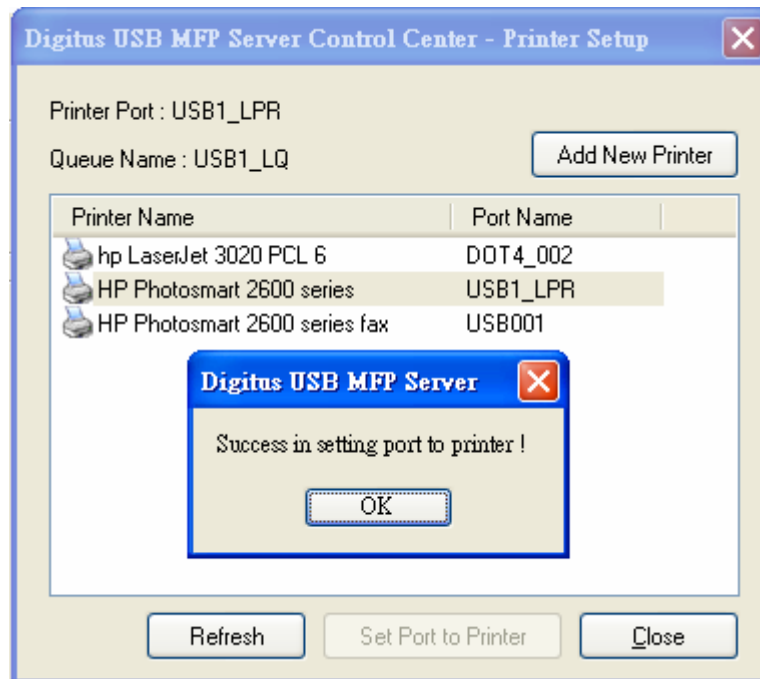

5. If you cannot find any printer driver in Printer List, please install your printer driver first or click **Add New Printer** to install the printer driver.

#### 4.4.3 Using Standard Windows Method for Raw TCP Printing

**Windows Platform:** Windows 2000, XP and 2003

1. Open **Printers and Faxes**
2. Right-click the printer for which you want to change settings, and then click **Properties**
3. Clear **Enable bidirectional support** and click **Add port**, and then click Standard TCP/IP Port from the dropdown and click **New port**.
4. The "**Add Standard TCP/IP Printer Port Wizard**" will pop up and click **Next**.
5. In the **Printer Name or IP Address** box, enter the Server Name of the Server or IP address of the Server. In the **Port Name** box, enter **USB1\_RAW** or **USB2\_RAW** for printer connected to USB1 port and USB2 port, respectively.  
☞ If your Server is running on a different LAN than your Windows PC such as Internet PC, you must enter the Server's IP address in **Printer Name or IP Address** box.
6. Click **Next**.
7. Click **Custom/settings**.
8. The click Settings and confirm that the settings are as below. The default Port Number values are 9100, 9101 for USB port 1 and USB port 2, respectively.

Refer to the Server's web pages or the Control Center, you can get exact values. Click **OK**.

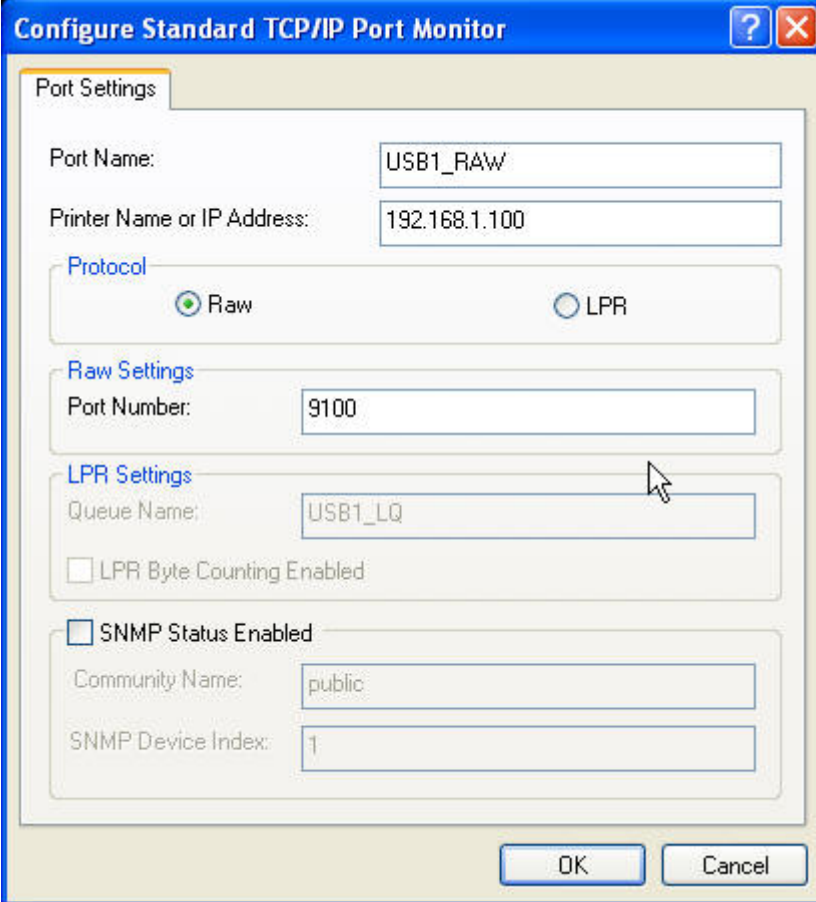

The screenshot shows a Windows dialog box titled "Configure Standard TCP/IP Port Monitor". It has a blue title bar with a question mark and a close button. The dialog is divided into several sections:

- Port Settings:** Contains two text input fields: "Port Name:" with the value "USB1\_RAW" and "Printer Name or IP Address:" with the value "192.168.1.100".
- Protocol:** Contains two radio buttons: "Raw" (which is selected) and "LPR".
- Raw Settings:** Contains a text input field for "Port Number:" with the value "9100".
- LPR Settings:** Contains a text input field for "Queue Name:" with the value "USB1\_LQ". Below it is a checkbox for "LPR Byte Counting Enabled" which is unchecked.
- SNMP Status:** Contains a checkbox for "SNMP Status Enabled" which is unchecked. Below it are two text input fields: "Community Name:" with the value "public" and "SNMP Device Index:" with the value "1".

At the bottom right of the dialog are two buttons: "OK" and "Cancel".

9. Click **Finish**.

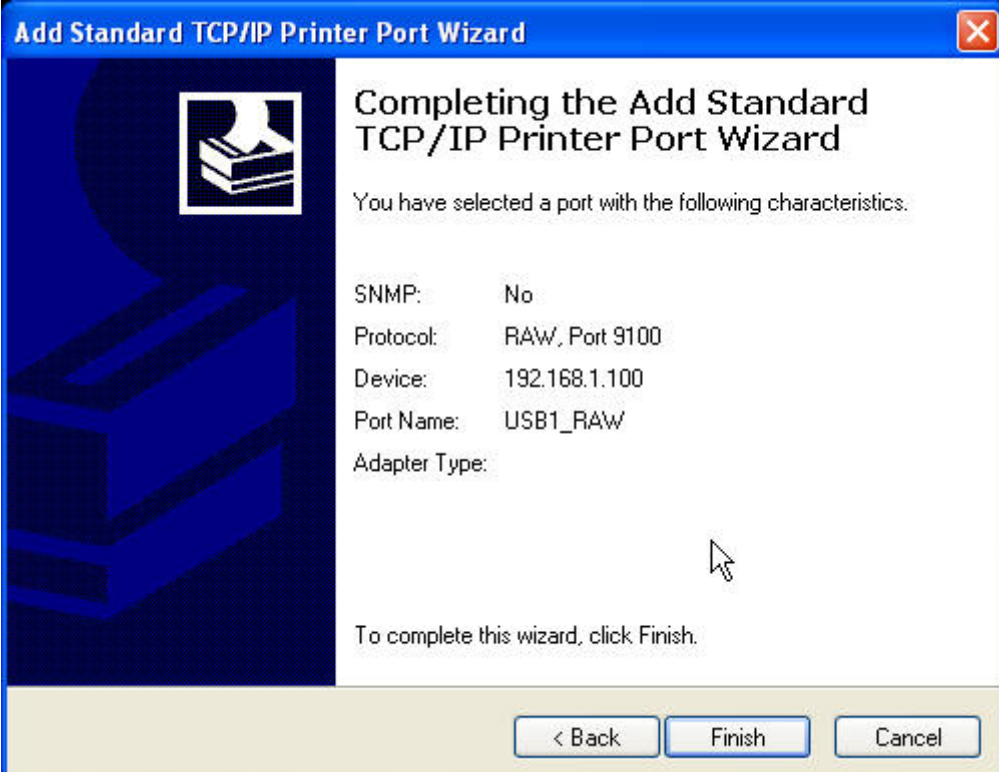

The screenshot shows a Windows dialog box titled "Add Standard TCP/IP Printer Port Wizard". It has a blue title bar with a close button. The dialog is split into two main areas:

- Left Panel:** A dark blue area with a white icon of a printer and a stack of papers.
- Right Panel:** Contains the text "Completing the Add Standard TCP/IP Printer Port Wizard" and "You have selected a port with the following characteristics." Below this is a list of settings:
  - SNMP: No
  - Protocol: RAW, Port 9100
  - Device: 192.168.1.100
  - Port Name: USB1\_RAW
  - Adapter Type:

At the bottom of the right panel, it says "To complete this wizard, click Finish." At the bottom of the dialog are three buttons: "< Back", "Finish", and "Cancel".

#### 4.4.4 Using the Control Center for Raw TCP/JetDirect Printing

**Windows Platform:** Windows 2000, XP and 2003

1. Start the Control Center, right-click on your Server and select **Set Printer**.
2. Select USB1 Port or USB2 Port to add the printer in **Set printer in** box, choose to use or IP address to represent the Server in **Select IP Address or Host Name in printer port** box, and select the network printing protocol of **Print with Raw TCP Mode**.

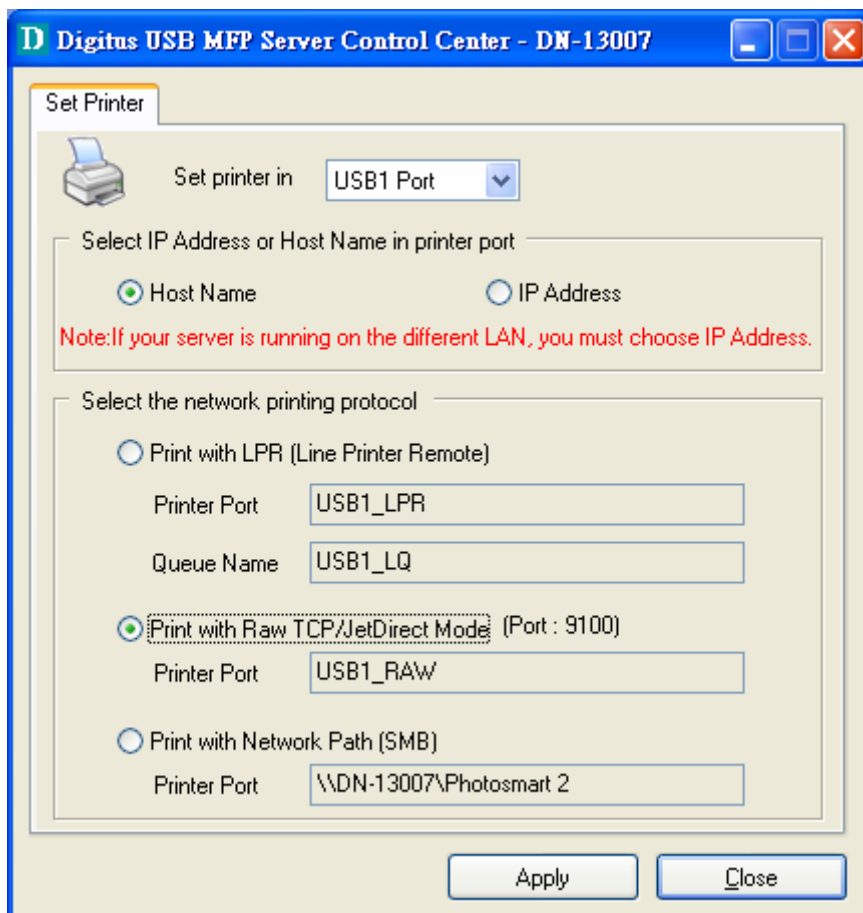

*✎ If your Server is running on a different LAN than your Windows PC such as Internet PC, you must choose IP address in **Select IP Address or Host Name in printer port** box.*

3. Click **Apply**.
4. Select the desired printer driver and click **Set Port to Printer**.

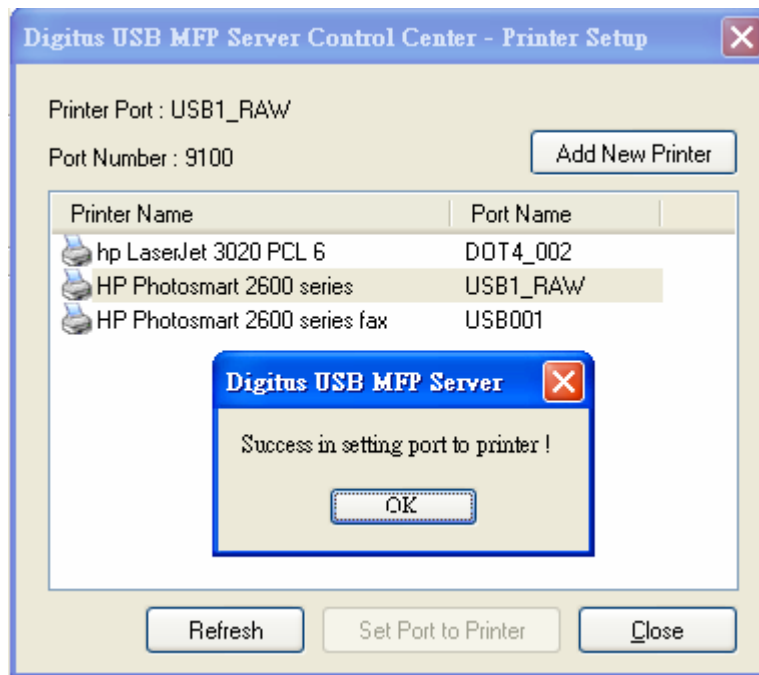

5. If you cannot find any printer driver in Printer List, please install your printer driver first or click **Add New Printer** to install the printer driver.

#### 4.4.5 Using Standard Windows Methods for SMB/CIFS Printing

- ✎ *Before using SMB/CIFS printing, you have to login the SMB/CIF Print/File server in advance and then you may use it; otherwise you have to disable SMB/CIFS Print/File Server Authentication.*
- ✎ *If you use SMB on Windows 98 SE/ME with Server Authentication, you must login to your Windows 98 SE/ME using the same user name as in the Server's User Account.*

**Windows Platform:** Windows 98SE, ME, 2000, XP and 2003

1. Open **Printers and Faxes**
2. Right-click the printer for which you want to change settings, and then click **Properties**.
3. Click the **Ports** tab.
4. Clear **Enable bidirectional support** and click **add port**, and click **Local Port**, and then click **New Port...** in the **Printer Ports** box.



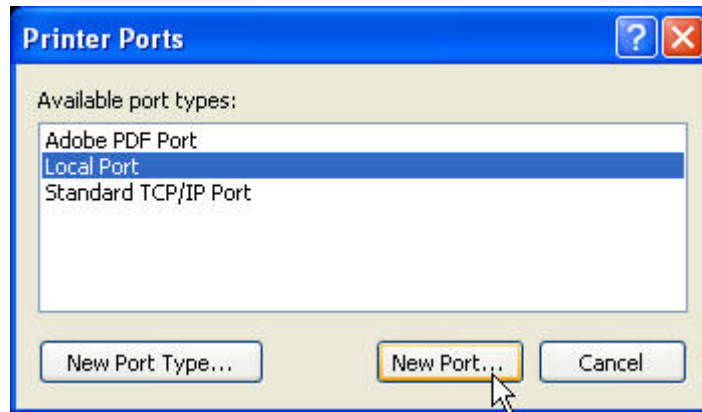

- In the **Port Name** box, enter the path to the printer with the following format: "\\ *Server's Server Name*\printer name" or "\\ *Server's IP address*\printer name" (Please refer to the Server's web pages or the Control Center to know exact path). For example: if you set the server name as "DN-13007" and the printer name (USB1 port) as Photosmart 2, then the network path is expressed as: \\DN-13007\Photosmart 2

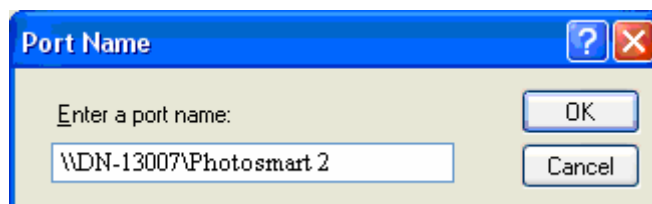

*If your Server is running on a different LAN than your windows PC such as Internet PC, you must enter IP address in **Port Name** box.*

- Click **OK**, and then select a Windows driver for your printer. If you already have the printer's driver installed, you will be asked whether to keep it or to replace it. Click **Next**.
- Choose whether you want to share the printer with other network users. Do you want to print a test page? Select the appropriate radio button and click **Next** and **Finish**.

#### 4.4.6 Using the Control Center for SMB/CIFS Printing

- Before using SMB/CIFS printing, you have to login the SMB/CIF Print/File server in advance and then you may use it; otherwise you have to disable SMB/CIFS Print/File Server authentication.*
- If you use SMB on Windows 98 SE/ME with Server Authentication, you must login to your Windows 98 SE/ME using the same user name as in the Server's User Account.*

**Windows Platform:** Windows 98, ME, 2000, XP and 2003

- Start the Control Center, right-click on your Server and select **Set Printer**.
- Select USB1 Port or USB2 Port to add the printer in **Set printer in** box, choose

to use Server Name or IP address to represent the Server in **Select IP Address or Host Name in printer port** box, and select the network printing protocol of **Printing with Network Path (SMB)**.

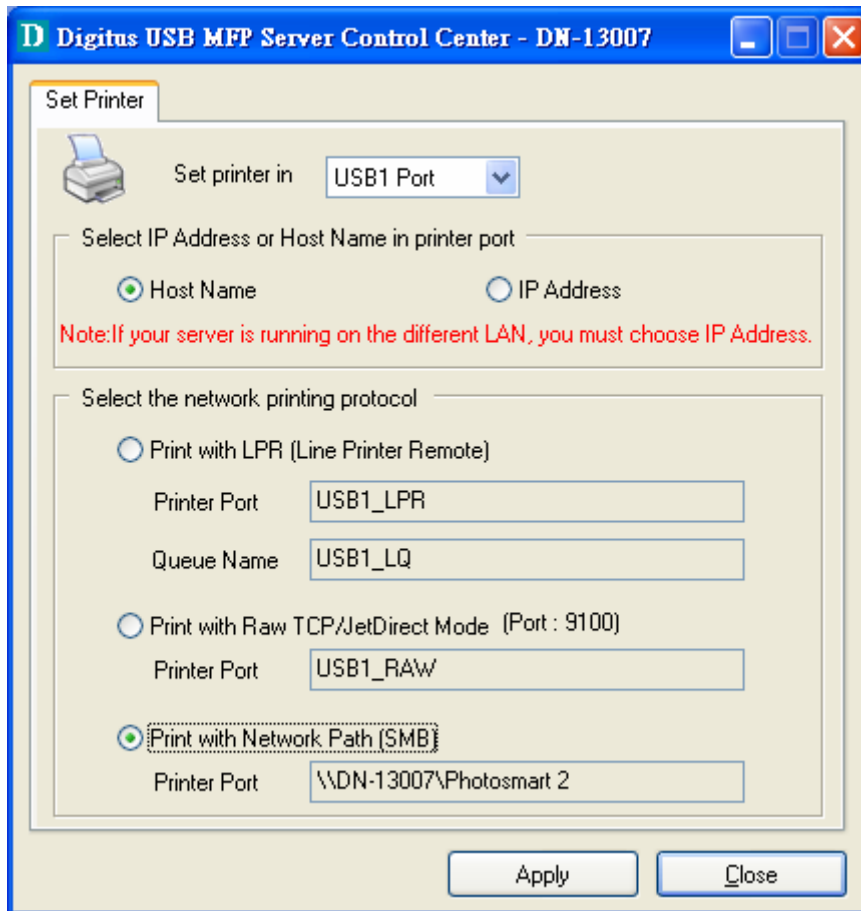

✎ If your Server is running on a different LAN than your Windows PC such as Internet PC, you must choose IP address in **Select IP address or Host Name in printer port** box.

3. Click **Apply**.
4. Select the desired printer driver and click **Set Port to Printer**.

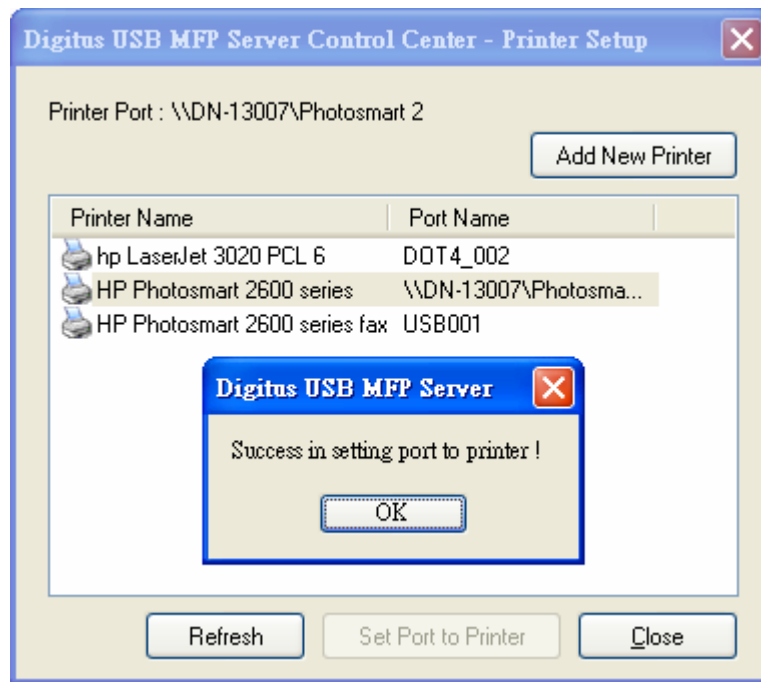



5. If you cannot find any printer driver in Printer List, please install your printer driver first or click **Add New Printer** to install the printer driver.

#### 4.4.7 Using Standard Windows Method for IPP Printing

**Windows Platform:** Windows 98 SE, ME, 2000, XP and 2003

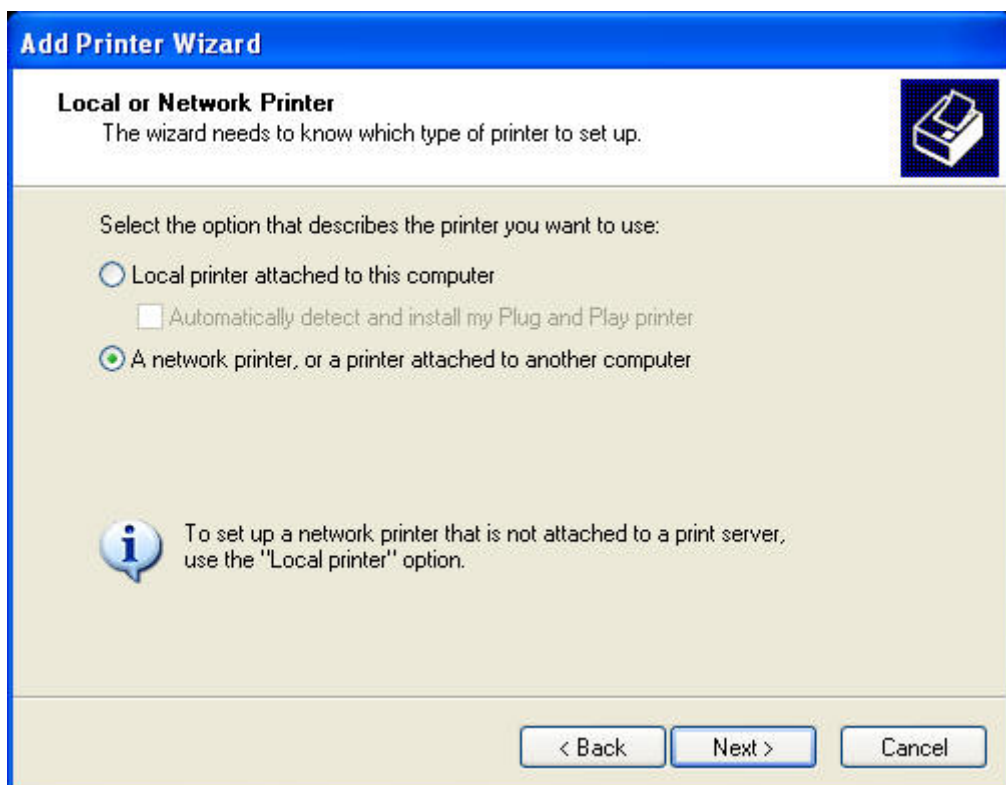
1. Click Start, click **Control Panel**, click Printers and Other Hardware, and then click Printers and Faxes.



2. Double click Add Printer to start the Add Printer Wizard, and then click **Next**.
3. In this window, select **A network printer, or a printer attached to another computer** and click **Next**.
4. Click the **Next** button. On the next window, select Connect to a printer on the Internet or on a home or office network. In the URL: field, enter the following to connect to the Server: *http://Server's Server Name /printer name* or *http://Server's IP address /printer name*  
For example, http://DN-13007/Photosmart 2  
 *If your Server is running on a different LAN than your windows PC such as Internet PC, you must enter IP address in **URL: Field**.*

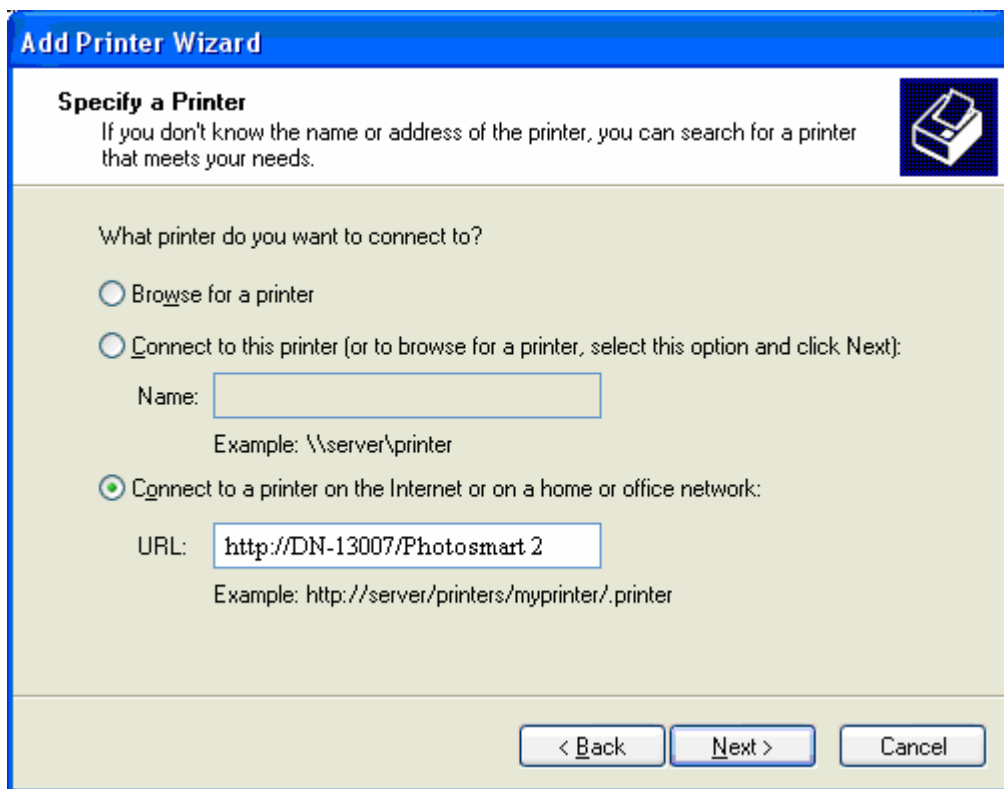

5. Click **Next** and then continue Windows Add Printer Wizard.

# Chapter5 Print Server in Unix/Linux

This chapter describes how to add network printers to Unix/Linux PC.

## 5.1 Configuring Host File

If using IP administration system like DNS, manually registering the Server Name and IP address may be not required. Otherwise, you have to edit hosts file and contact your network administrator.

1. Log in to Linux machine by "root".

*# login root*

2. Register the Server's Server Name and IP address into /etc/hosts file.

*To edit host file, use an editor, e.g. "vi".*

**Example:** The IP address is "192.168.1.100", Server Name is "DN-13007"

192.168.1.1            dns                    # DNS Server

192.168.1.2           mail                    # Mail Server

192.168.1.100        DN-13007                # Server

3. Switch on the Server. Verify the network connection by using the ping command.

*# ping DN-13007*

If there is no response or error occurs, there may be problems with IP address configuration, host file editing or network status. Please contact your network administrator.

## 5.2 Printing by LPD/LPR

This section explains how to print using LPD protocol of TCP/IP.

For further information on "lpr" and "lp" commands, refer to your workstation manual.

**LPD Protocol:** LPD (Line Printer Daemon) is a protocol that enables you to execute printing to a printer on the network.

**Remote-Printer Queue:** The Server has two remote printer queues: USB1\_LQ and USB2\_LQ with respect to USB port 1 and UB port2.

To print files using a printer driver, use "lp" or "lpr".

## 5.3 Using the Server on BSD UNIX/Linux

1. Log in to the BSD Unix machine through "root".

*# login root*

2. Register the Server into /etc/printcap file.

Example: To register the printer of USB1 port by the printer name "Printer1".

Printer1:\ ---(A)

:lp=:rm=DN-13007:rp=USB1\_LQ:\ ---(B)

```
:sd=/var/spool/lpd/Printer1:\ ---(C)
:lf=/var/spool/lpd/Printer1/Printer1_errs: ---(D)
```

where

(A) Describes the printer name.

(B) lp: Device file name to connect printer. No name designation required on the network.

rm: Server Name for the remote printer. Enter the Server Name registered to /etc/hosts file.

rp: Remote printer name. Please input the remote printer queue name.

(C) sd: Spool directory name. It must be the absolute path.

(D) lf: Error log file name. It must be the absolute path.

3. Create the spool directory and error log file registered to /etc/printcap file. Example: To create the spool directory "Printer1" and error log file "Printer1\_errs".

```
# mkdir /var/spool/lpd/Printer1 Create the spool directory
```

```
# touch /var/spool/lpd/Printer1/Printer1_errs Create the error log file
```

```
# chown -R daemon /var/spool/lpd/Printer1 Change the owner to daemon
```

```
# chgrp -R daemon /var/spool/lpd/Printer1 Change the group to daemon
```

4. Start Printing.

A. Use the "lp" command.

```
-# lp -d Printer1 <Print file name>
```

```
-# lp -d Printer2 <Print file name>
```

B. Use the "lpr" command.

```
-# lpr -P Printer1 <print file name>
```

```
-# lpr -P Printer2 <Print file name>
```

## 5.4 Using the Server on RedHat Linux (Fedora Core)

In the RedHat (Fedora Core) x-window user interface, follow these steps:

1. To start the application, select **Main Menu** button (on the Panel)-> **Applications**->**System Settings** -> **Printing**.

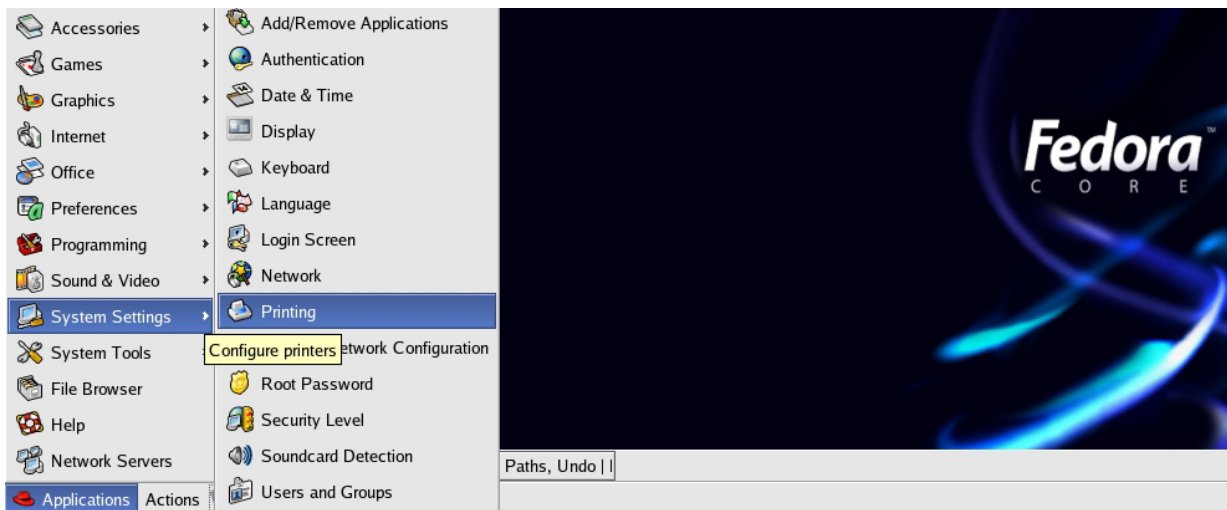

2. Click on the **New** button in the **Printer configuration** window.

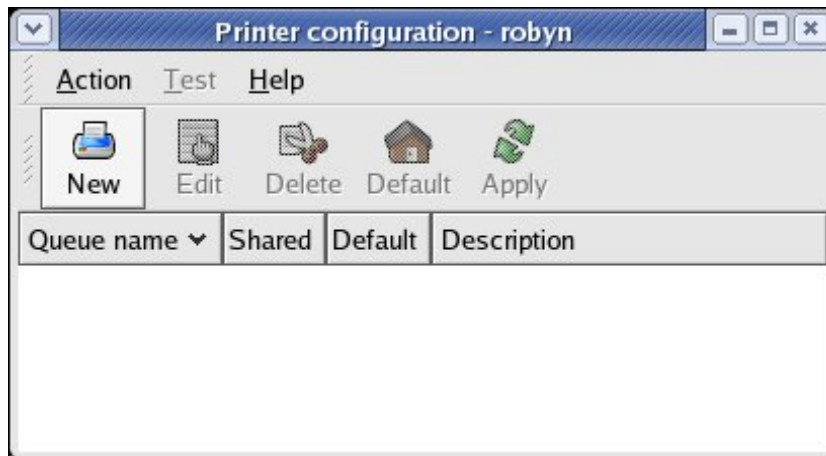

3. Click on the **Forward** button in the **Add a new print queue** window.



4. Fill in your desired printer name and description (optional) in **Queue name** window and then click on the **Forward** button.

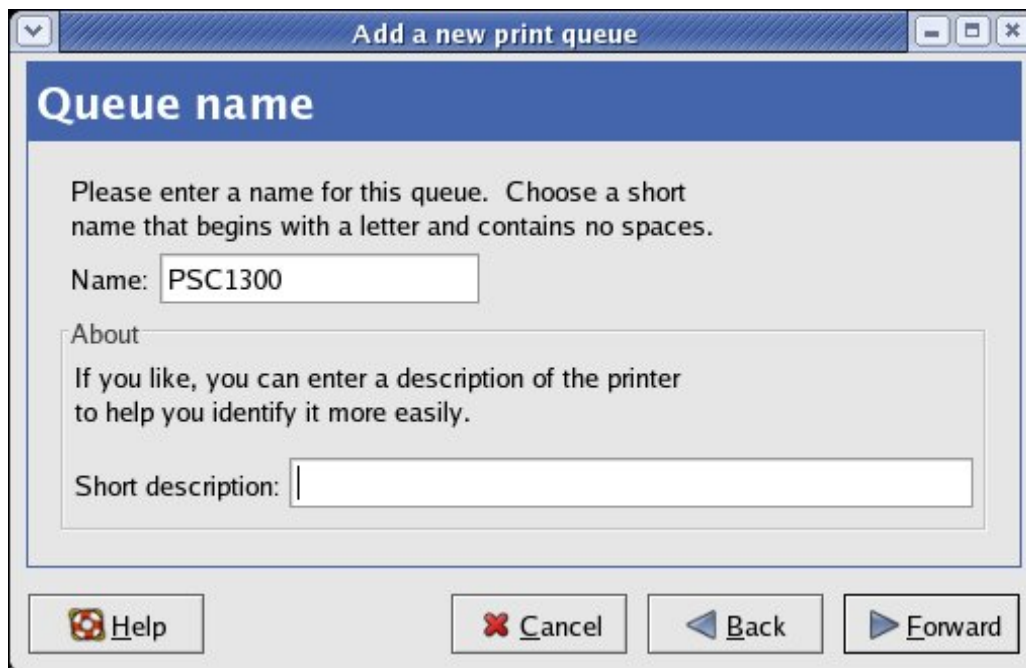

5. In **Queue type** window, you will now be asked to specify which Printer Queue type you are using, select the one option from **Networked Unix (LPD)**, **Networked CUPS (IPP)**, **Networked Windows (SMB)** and **Networked JetDirect** options. Click on the **Forward** button.

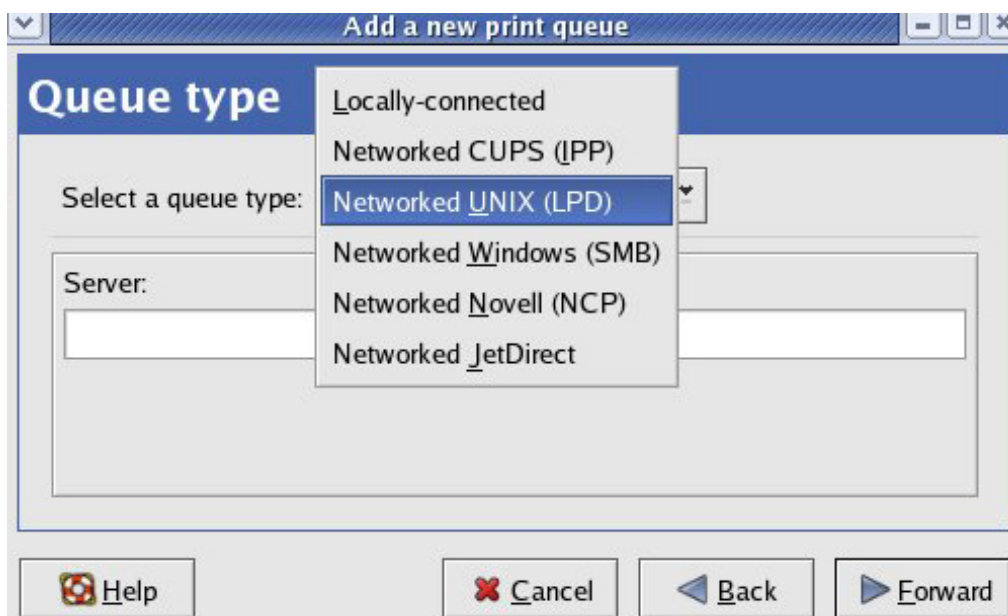

6. Fill in parameters for **Queue type** window:
  - A. **Networked Unix (LPD)**: Fill in the Server's IP address and queue name and then click the **Forward** button. *Example:* If your Server's IP address is 192.168.1.100 and it connects to HP PSC 1300 MFP via USB1 port. You can



enter IP address in the Server box as 192.168.1.100 and Queue name in Queue box as USB1\_LQ.

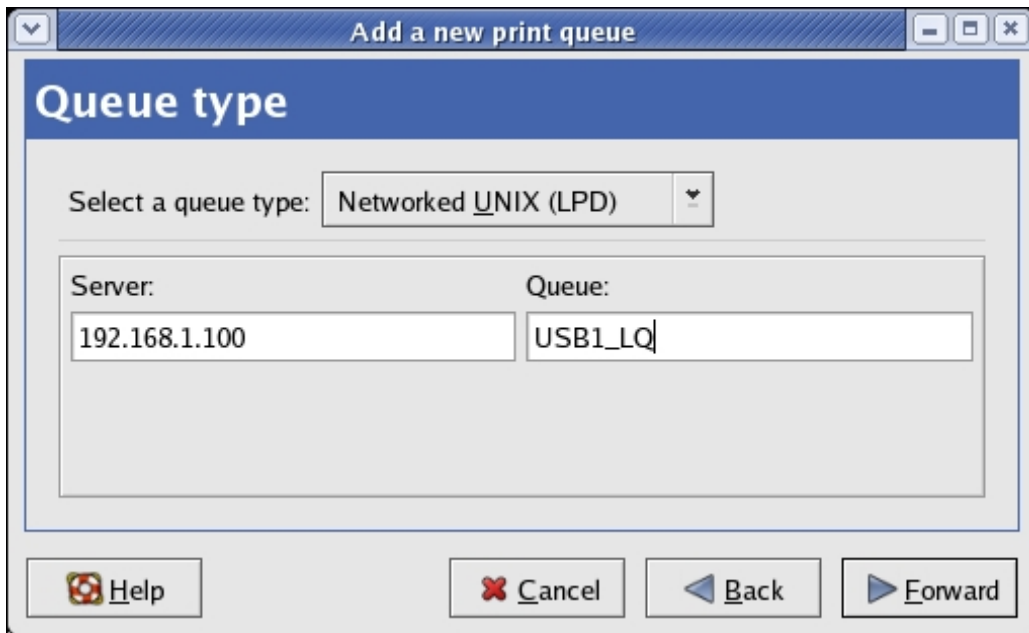

The screenshot shows a window titled "Add a new print queue" with a blue header bar. Below the header, the text "Queue type" is displayed. A dropdown menu labeled "Select a queue type:" is set to "Networked UNIX (LPD)". Below this, there are two input fields: "Server:" containing "192.168.1.100" and "Queue:" containing "USB1\_LQ". At the bottom of the window, there are four buttons: "Help" (with a question mark icon), "Cancel" (with a red X icon), "Back" (with a left arrow icon), and "Forward" (with a right arrow icon).

- B. **Networked JetDirect:** Fill in the Server's IP address and protocol's TCP port and then click the **Forward** button. *Example:* If your Server's IP address is 192.168.1.100 and it connects HP PSC 1300 MFP via USB1 port. You can enter IP address in the Server box as 192.168.1.100 and TCP Port in **Port** box as 9100.

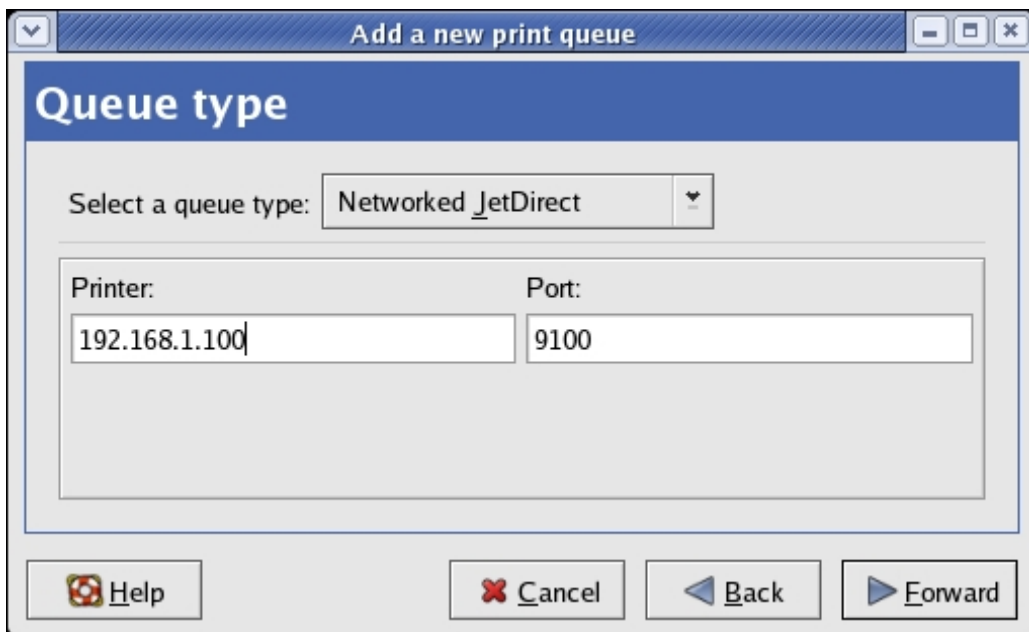

The screenshot shows a window titled "Add a new print queue" with a blue header bar. Below the header, the text "Queue type" is displayed. A dropdown menu labeled "Select a queue type:" is set to "Networked JetDirect". Below this, there are two input fields: "Printer:" containing "192.168.1.100" and "Port:" containing "9100". At the bottom of the window, there are four buttons: "Help" (with a question mark icon), "Cancel" (with a red X icon), "Back" (with a left arrow icon), and "Forward" (with a right arrow icon).

- C. **Networked Windows (SMB):**
- Click on the **Specify** button to specify SMB server Authentication.

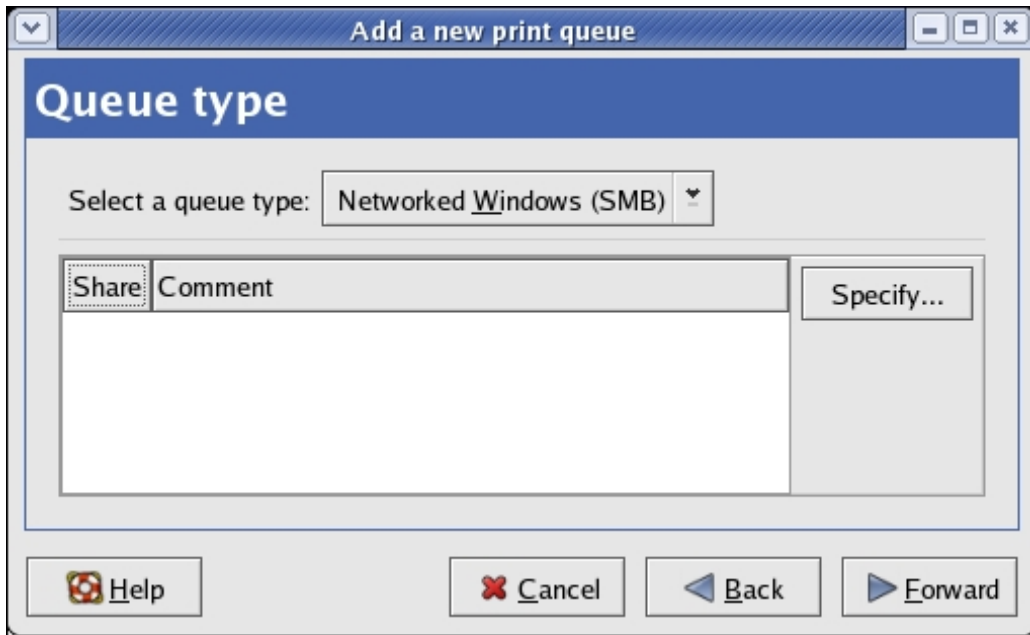

- ii. Fill in the Workgroup, Server Name, User name and Password in **Authentication** window and then click on the **OK** button.



- iii. Click on the **Forward** button.

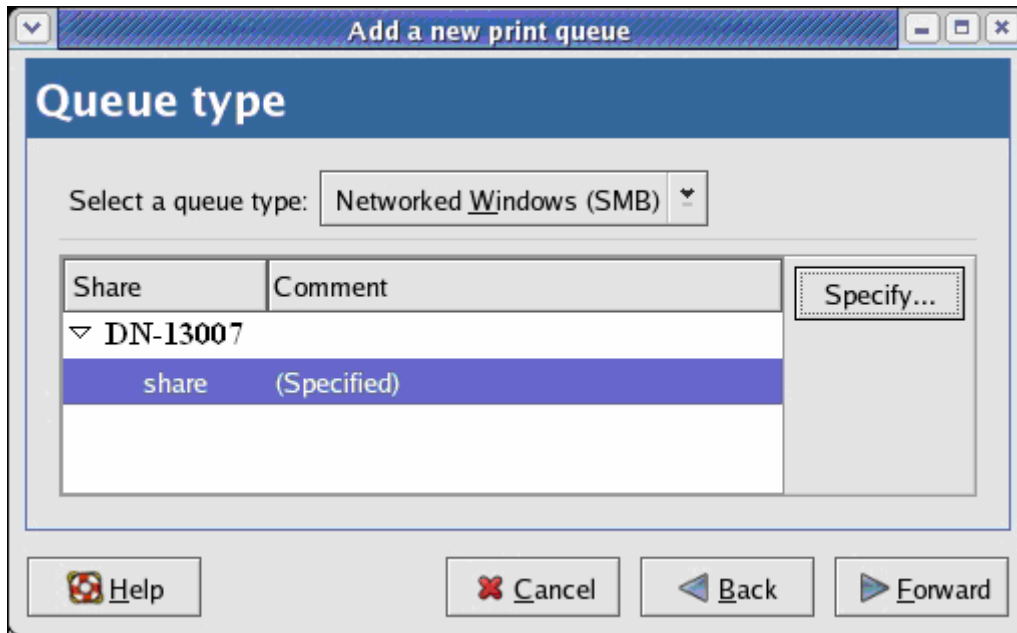

- D. **Networked CUPS (IPP):** Fill in the Server's IP address and printer name then click the **Forward** button. *Example:* If your Server's IP address is 192.168.1.100 and its printer name is **psc 1300 ser**. You can enter IP address in **Server** box as 192.168.1.100 and printer name in **Path** box as **psc 1300 ser**.

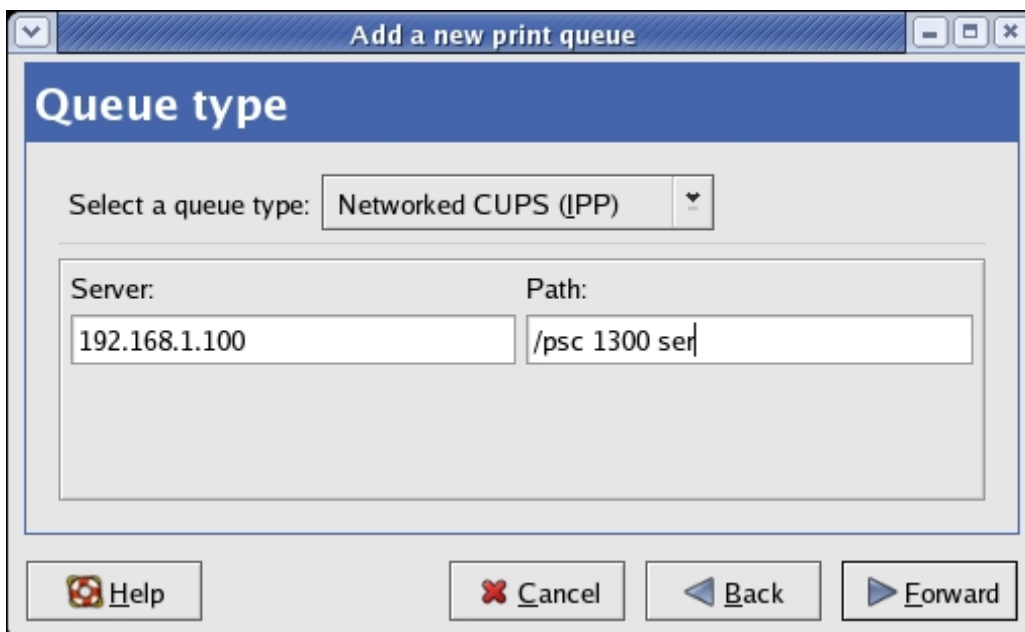

7. Select your printer driver. Click on the **Forward** button. Windows will display the **Finish, and create the new print queue** folder.

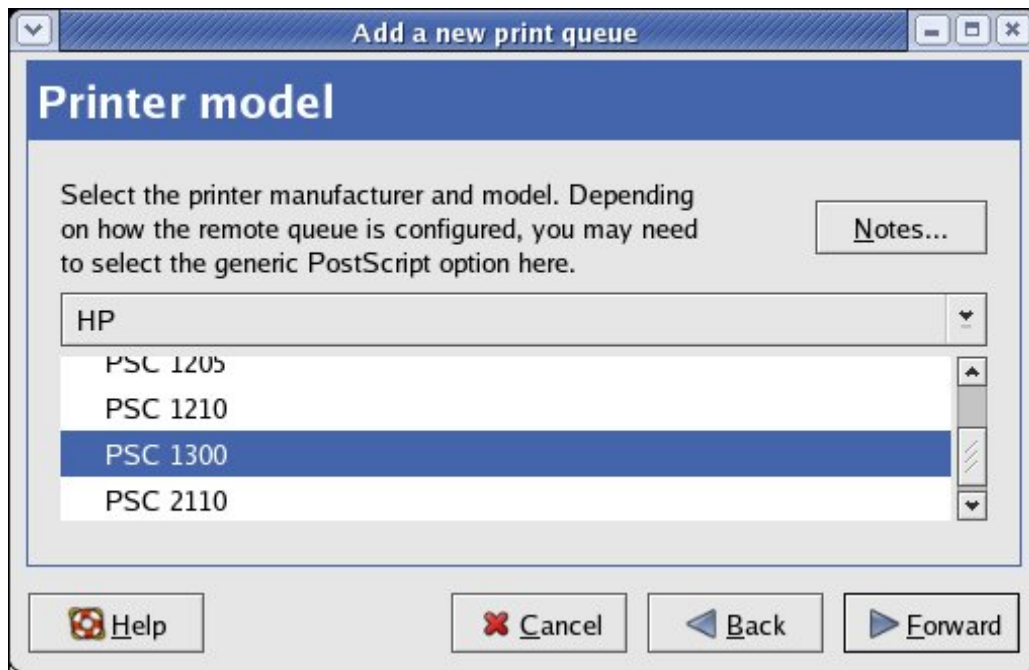

8. Click **Finish** button.

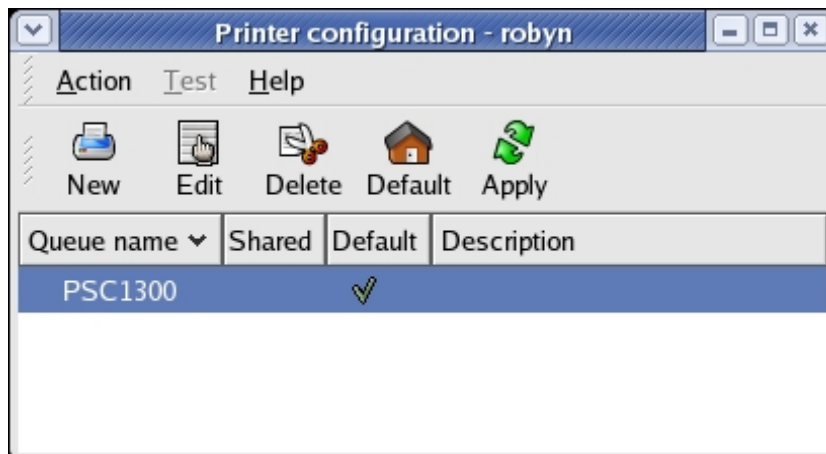

## Chapter 6 File Server

This chapter describes the file server function of the Server which allows USB storage devices to be shared across a network by using SMB: NetBIOS over TCP/IP and FTP protocol.

### 6.1 Preliminary

1. This product supports a file format of FAT12/16/32 and NTFS. However, the “write” operation on NTFS is only supported in NetUSB mode. Please refer to the Storage Access Mode.
2. Digitus Corporation is not responsible for the loss or corruption of data in memory devices, including hard disk; Digitus is not responsible for the leak, manipulation, loss, or corruption of data in memory devices connected to the Server after unauthorized access.
3. In order to use the USB Mass Storage device connected to the Server, the SMB protocol or FTP protocol must be set up.
4. This product does not support to magnet optical drive devices such as CD/DVD.
5. This product allows shared two USB storage devices over the network in Windows through the USB ports.
6. This product does not support the USB devices through USB hub.

### 6.2 Storage Names

The local drives of the two storages in USB1 port and USB2 port are named as USB<sub>x</sub>\_D<sub>x</sub>P<sub>x</sub>, where USB<sub>x</sub> represents the USB<sub>x</sub> port, D<sub>x</sub> represents the the x-th Disk and P<sub>x</sub> represents the x-th partition.

### 6.3 Connecting USB Mass Storage to the Server

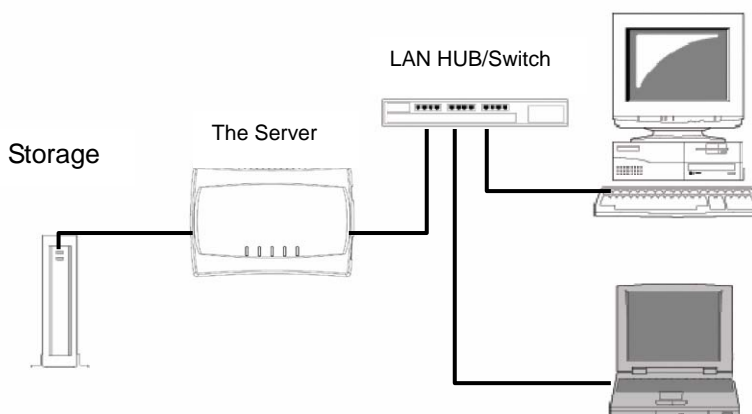

## 6.4 Supported Codepages

### - What is codepage?

Used by the system to encode and interpret string characters. Codepage formats are not the same for each language. Some languages, such as Japanese have multibyte characters, while others, such as English and German, need only one byte to represent each character.

### - Filename Encoding of FAT File System

This is known as an **8.3** file name, a short file name using codepage encoding. The FAT file system also supports file names that can be up to 255 characters long. This is known as a long file name using Unicode (UTF-16) encoding.

### - When do you need to configure codepage?

The Server supports Windows codepages. If users want to communicate files using FTP client tool or SMB on Windows 98/Me/2000 with the Server, they have to set their Server codepage to be same as the codepage that their Windows PC is using.

1. FTP
2. SMB on Windows 98/Me/2000

### - Configuring the Server's Codepages

Users can use the following methods to set the Server's codepage.

#### A. Using Control Center

1. Start Control Center and Auto-searching Server window will appear.
2. If the tool finds the Servers in your local area network, then you have to select one Server from the Server List.
3. Double click the highlight list and enter the Server's administrator (default: *admin*) and password (default: *admin*).
4. After you have logged in successfully, setting **General Configuration** dialog appears.

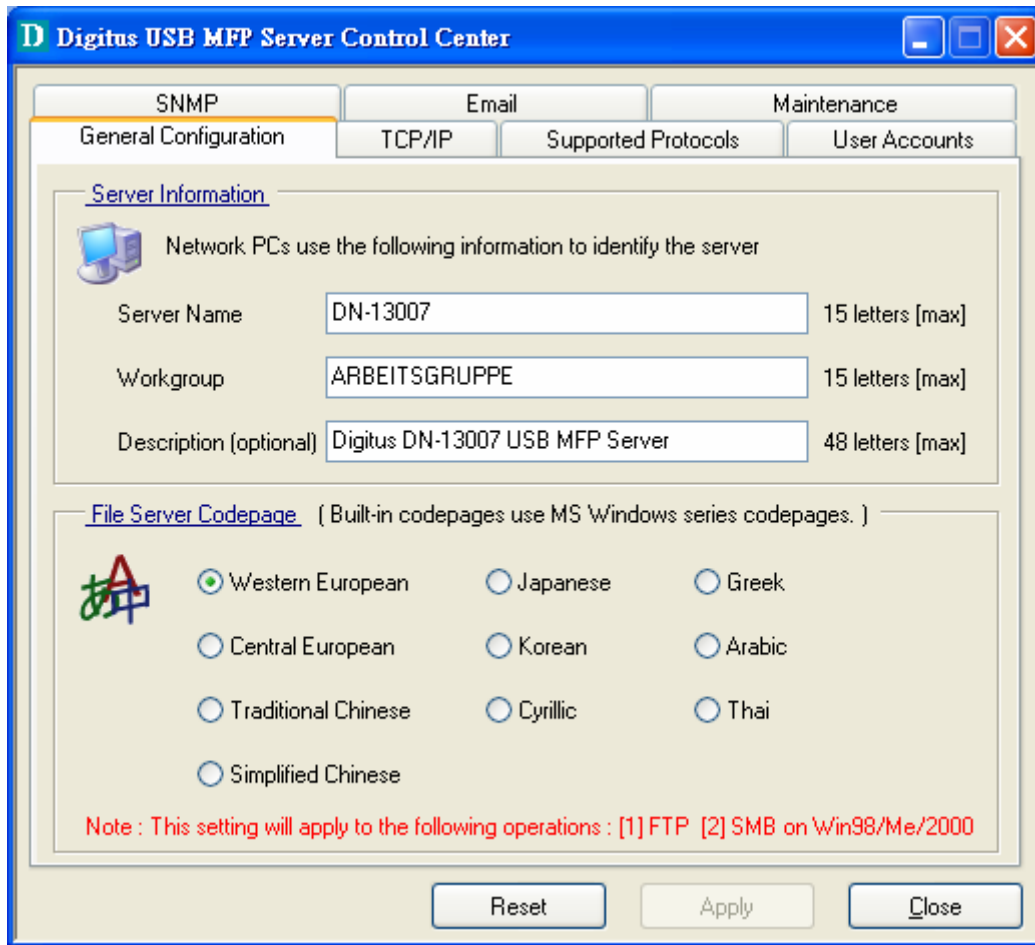

5. Select your codepage form **File Server Codepage** box and click **Apply**.

#### B. Using Server's Web Pages

1. Go to the web page, click **CONFIG**
2. Login your administrator (default: *admin*) and password (default: *admin*).
3. After you have logged in successfully, setting **General Configuration** dialog appears.

**File Server Code Page**

- Western European
- Central European
- Traditional Chinese
- Simplified Chinese
- Japanese
- Korean
- Cyrillic
- Greek
- Arabic
- Thai

\* Built-in codepages use MS Windows series codepages.  
 \* This setting will apply to the following operations :  
 1. FTP (File Transfer Protocol)  
 2. SMB on Windows98/ME/2000

4. Select your codepage form **File Server Codepage** box and click **Apply**.

## 6.5 Adding Your USB Mass Storages to Network with Security

You can use the following protocols to share your USB Mass Storages with user level security in network:

- SMB/CIFS: NetBIOS over TCP/IP
- FTP

The protocols are shown in **Supported Protocols** box of the Control Center or the Server's web pages.

### 6.5.1 Setting up File Server Using the Control Center

1. Start the Control Center and Auto-searching Server window will appear.
2. If the tool finds multiple Servers in your local area network, then you have to select one Server from the Server List.
3. Double click the highlight list and enter the Server's administrator (default: *admin*) and password (default: *admin*).
4. After you have logged in successfully, click **Supported Protocols**.



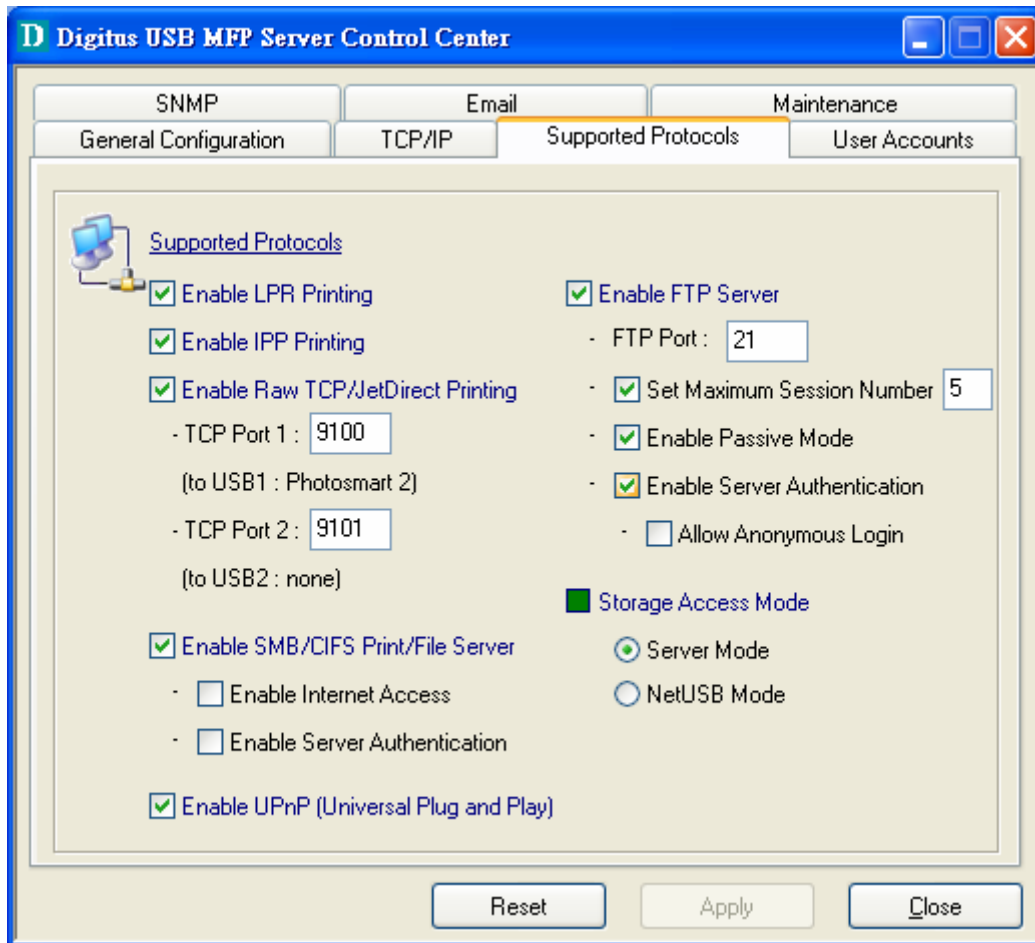

5. Set up File Server Configuration:

A. Set SMB/CIFS Print/File Server

- **Enable SMB/CIFS Print/File Server:** select the item, if you want to support SMB/CIFS print/File server.
- **Enable Internet Access:** clear the item, if you do not allow that users can access your SMB/CIFS server via Internet. If you select the item, you allow Internet users can access your storage using the SMB/CIFS protocol.
- **Enable Server Authentication:** select the item, if you want to share your storage with user level security which requires user name and password to login. If you clear the item, your storage will be shared without security.

B. Set FTP Server:

- **Enable FTP Server:** select the item, if you want to support FTP server.
- **FTP port:** enter the desired FTP port. The default value is 21.
- **Maximum Session Number:** select the item and fill in desired

- number.
- **Enable Passive Mode:** select the item, if you want to allow that your FTP server can accept passive mode command.
  - **Enable Server Authentication:** select the item, if you want to share your storage with user level security which requires user name and password to login. If you clear the item, your storage will be shared without security.
  - **Allow Anonymous Login:** select the item, if you want to allow the user "anonymous" to login your FTP server with read-only permission and the Server will not check the password. If you clear the item, your FTP server will not support anonymous login function.
- c. **Storage Access Mode:** To use FTP and SMB/CIFS to access storage, please set the storage access mode to the server mode. For the NetUSB mode, please refer to chapter 9.

### 6.5.2 Setting up File Server Using Web Pages

1. Go to the web page, click **CONFIG**
2. Login your administrator (default: *admin*) and password (default: *admin*).
3. After you have logged in successfully, click **Supported Protocols**.

**Set Supported Protocols**

**TCP/IP**

Enable LPR Printing

Enable IPP Printing

Enable Raw TCP/JetDirect Printing

- TCP Port  (to USB1 )

- TCP Port  (to USB2 )

Enable SMB/CIFS Print/File Server

-  Enable Internet Access

-  Enable Server Authentication

Enable FTP Server

- FTP Port

-  Set Maximum Session Number

-  Enable Passive Mode

-  Enable Server Authentication

-  Allow Anonymous Login

Enable SANE Server

- SANE Port

Enable UPnP (Universal Plug and Play)

**Storage Access Mode**

Server Mode  NetUSB Mode

#### 4. Set up File Server Configuration:

##### A. Set SMB/CIFS Print/File Server

- **Enable SMB/CIFS Print/File Server:** select the item, if you want to support SMB/CIFS print/File server.
- **Enable Internet Access:** clear the item, if you do not allow that users can access your SMB/CIFS server via Internet. If you select the item, you allow Internet users can access your storage using the SMB/CIFS protocol.
- **Enable Server Authentication:** select the item, if you want to share your storage or printer with user level security which requires user name and password to login. If you clear the item, your storage will be shared without security.

##### B. Set FTP Server:

- **Enable FTP Server:** select the item, if you want to support FTP server.
- **FTP port:** enter the desired FTP port. The default value is 21.
- **Maximum Session Number:** select the item and fill in desired number.
- **Enable Passive Mode:** select the item, if you want to allow that your FTP server can accept passive mode command.
- **Enable Server Authentication:** select the item, if you want to share your storage with user level security which requires user name and password to login. If you clear the item, your storage will be shared without security.
- **Allow Anonymous Login:** select the item, if you want to allow the user "anonymous" to login your FTP server with read-only permission and the Server will not check the password. If you clear the item, your FTP server will not support anonymous login function.

C. Storage Access Mode: To use FTP and SMB/CIFS to access storage, please set the storage access mode to the server mode. For the NetUSB mode, please refer to chapter 9.

### 6.5.3 Using Shared Storages by SMB/CIFS Method for Windows

1. Connect a USB storage device to this product.
2. Select **My Network Places**

3. Click **Display the Computers of Workgroup**
4. Double click **Microsoft Windows Network** icon.
5. Double click the **Workgroup** that the Server belongs to. The default Workgroup name is "*WORKGROUP*". You can refer to Control Center or the Server's web pages to get it. You will see that the Server is displayed as its server name.
6. If you cannot find Workgroup name of the Server in Microsoft Windows Network, you can select **Search for Computer...** in **My Network Places** and enter the Server Name of the Server to find it.
7. Double click this Server Name icon.
8. If you clear **Enable SMB/CIFS Print/File Server Authentication** in **Supported Protocols**, you login to the SMB server without requiring authentication; otherwise you have to enter user name and password to login to the Server. You can add user name and password in **User Account** box by the Control Center or the Server's Web page.

**Note:**

*If you use SMB on Windows 98 SE/ME, you must login to your Windows 98 SE/ME using the same user name as in the Server's **User Account**.*

9. The shared folders will be listed as USB1\_DyPz, and USB2\_DyPz where Dy represents the y-th disk and Pz represents the z-th partition with respect to USB1 port and USB2 port.
10. Perform Open, Paste, Remove or Copy the files to the shared folders.

Note: Another way to use shared storages by SMB/CIFS method : In Control Center, click the "Network Storage" button, as the following figure.

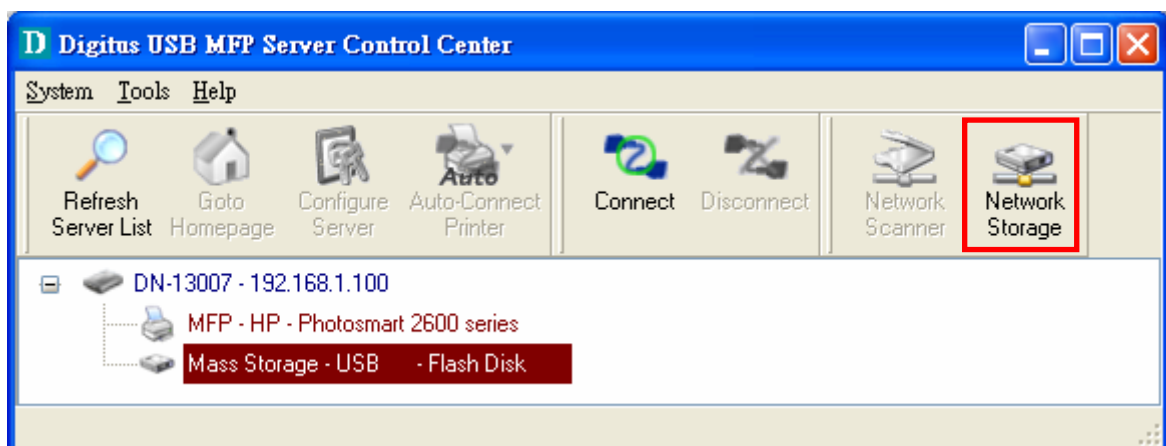

#### 6.5.4 Using Shared Storage by FTP Methods for Windows

- A. Use Microsoft IE to the shared USB Mass Storages

1. Open Microsoft IE
  2. In **Web Address List**, enter command: "*ftp://Server's Server Name*" or "*ftp://Server's IP address*". If you have changed the default FTP port : 21 to the new value, you have to add the new port number in the tail of command as "*ftp://Server's Server Name: ftp port*" or "*ftp://Server's IP address: ftp port*".
  3. If you set **Enable Server Authentication in FTP server protocol settings** you have to enter user name and password to login to the Server; if you set **Allow Anonymous Login**, you can use the user name "anonymous" to login with Read-only permission. If you clear Server authentication, you do not need username or password to login to the Server. You can add user name and password in **User Account** box by the Control Center or the Server's Web pages.
  4. The shared folders will be listed in IE.
  5. Perform Paste, Remove or Copy the files to the shared folders.
- B. Use Microsoft Dos's FTP client
1. Enter Dos command as "ftp"
  2. Enter "*open server's Server Name*" or "*open server's IP address*". If you have changed the default FTP port : 21 to the new value, you have to add the new port number in the tail of command as "*open server's Server Name ftp port*" or "*open server's IP address ftp port*" .
  3. If you set **Enable Server Authentication in FTP server protocol settings** you have to enter user name and password to login to the Server; if you set **Allow Anonymous Login**, you can use the user name "anonymous" to login with Read-only permission. If you clear Server authentication, you do not need username or password to login to the Server. You can add user name and password in **User Account** box the Control Center or the Server's Web pages.
  4. Perform FTP commands to use this FTP server.

# Chapter7 The NetUSB Technology

## 7.1 Introduction

The goal of Digitus DN-13007/DN-13008/DN-13018 USB MFP server is to provide the print/scan/file server in a single product. For printers and scanners, there is no industrial standard. In order to support many different models of printers and scanners from various vendors, one way is putting so many printer/scanner drivers into a single product. Obviously this is very hard and not practical. We have developed a new technology, called "NetUSB", to solve this problem. With the NetUSB technology, it is not necessary to implement printer/scanner drivers in Digitus DN-13007/DN-13008/DN-13018. Actually, DN-13007/DN-13008/DN-13018 relies on printer/scanner drivers that are installed on PCs. By the way, in the field of traditional network print server, the common protocols used are, for example, SMB/CIFS, LPR, raw TCP, and IPP. However, in order to reduce cost, many printer vendors produce so-called GDI or host-based printers. For technical reasons, these kinds of printers can not work with the traditional network printer protocols. The NetUSB technology can also deal with the problem. The basic concept and the usage of NetUSB will be introduced in this chapter.

In summary, DN-13007/DN-13008/DN-13018 has a totally different technology, "NetUSB", to deal with printers and scanners (MFPs).

- A. For printers, some special kinds of printers, such as GDI printers or host-based printers, can not work well with traditional print server technology as described in the previous chapters. Users should use the NetUSB technology to deal with these kinds of printers.
- B. For MFPs or scanners, the NetUSB technology is able to support almost all models from all MFP/scanner vendors..
- C. For USB mass storage, such as USB hard drives and flash drives and card readers on some kinds of MFPs, users can also use the NetUSB technology to access them in single-user mode. By this way, NTFS file system is supported for read/write. To use the NetUSB technology to access storage, please set the storage access mode to NetUSB mode. Please refer to chapter 8 for how to set the storage access mode.

Note: The default storage access mode is server mode.

## 7.2 Connect & Disconnect

"NetUSB" allows you to use USB printers or USB MFPs as if they were connected directly to your PC although they are actually connected to the USB MFP server. The "connect" operation is a software operation that simulates an actual USB device plug-in. That is to say, when you do a "connect" operation in the Control Center, PC can then detect a USB device's plug-in, although actually you do not plug in any USB device. Similarly, the "disconnect" operation is a software operation that simulates the

disconnection of the USB device. Once the connect operation is successful, the operations to use that USB device are just the same as if the USB device is directly connected to the PC.

If a USB device is “connected” by a PC, we say that PC has the ownership of the USB device. Only one PC can get the ownership of a USB device at the same time.

For printers, users can mix print jobs with traditional printing protocols, such as LPR or SMB or IPP, and with the NetUSB printing, as long as the printer is in “disconnect” state (that is, no PC get the ownership of that printer.) when a print job with traditional protocols occurs. For USB storage, if the storage access mode is in NetUSB mode, users can only use NetUSB technology to access storage. On the other hand, if the storage access mode is in server mode, users can only use FTP or SMB to access storage.

## 7.3 How to Use

### 7.3.1 Remote Installation

Here we will describe how to use the NetUSB technology to do “remote installation” for a USB device. Before using the NetUSB technology, you must first make sure that your PC can access Digitus USB MFP server via TCP/IP. The simplest way to do this is using “Control Center” to search for the Digitus USB MFP server on the network and change its IP address to be the same subnet as your PC. If the MFP server and your PC are not in the same TCP/IP subnet, Control Center will show the MFP server in green, as the following figure. You must change the IP address (or using DHCP) of the MFP server so that the MFP server and your PC are in the same subnet. Control Center will show these MFP servers in blue, meaning you can safely access these MFP servers by the NetUSB technology.

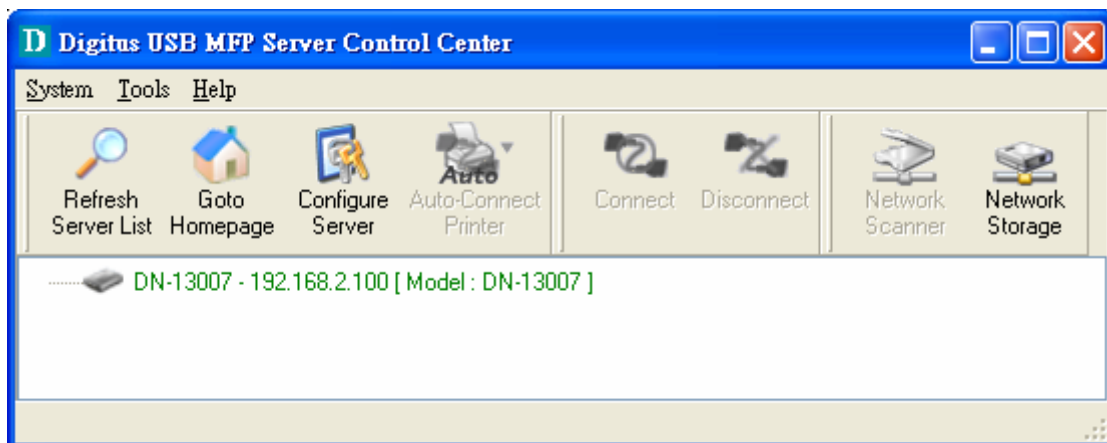

The steps to do remote installation for USB devices, like MFPs:

- A. Turn on the MFP Server and the USB device.
- B. Connect the USB device to the MFP Server. The LED of the USB port will light-on.
- C. Run the Control Center. In the “USB MFP Server List” window, you can see the server names and IP addresses all of the MFP servers (in blue) on the network, as the following figure.

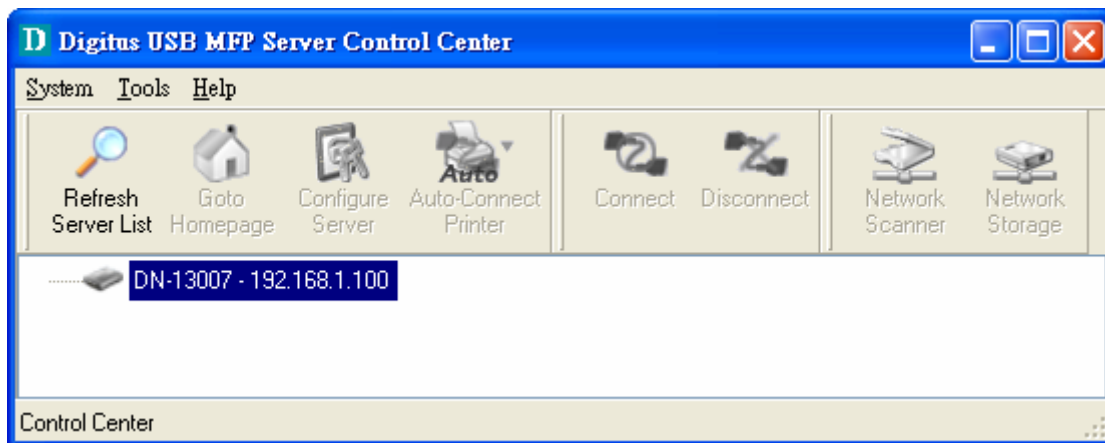

D. Click the server. Then all USB devices attached on the server will be shown.

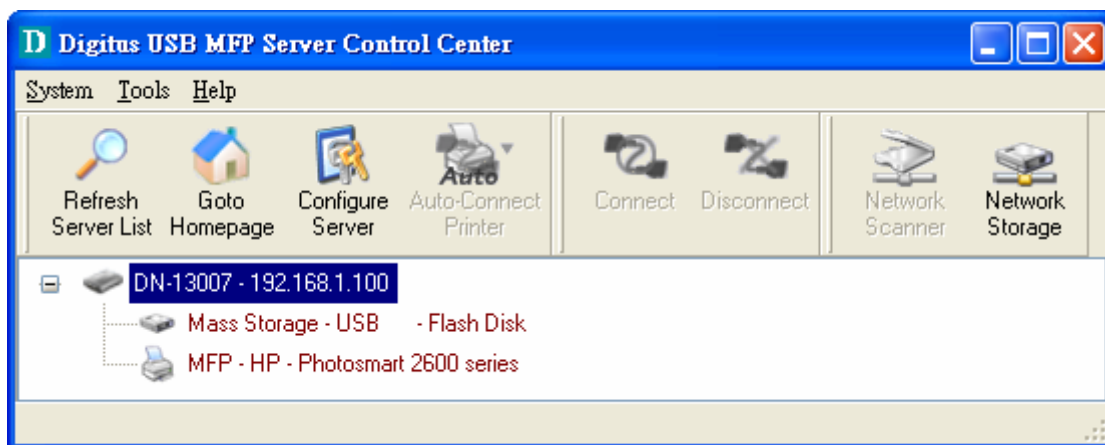

- E. Please follow the user manual of the USB device to do the driver installation. For example, you may put the driver CD of the USB device in the CDROM to install the driver.
- F. When you are asked to plug in the USB device into PC's USB port, either before running the driver setup program or during the execution of the driver setup program (This depends on the USB device. Please check the user manual from the vendor.), click the desired USB device in the Control Center and then click the "Connect" button to do the connect operation and get the ownership of the USB device, as the following figure. The computer name of the device owner will be shown at the end of the device.

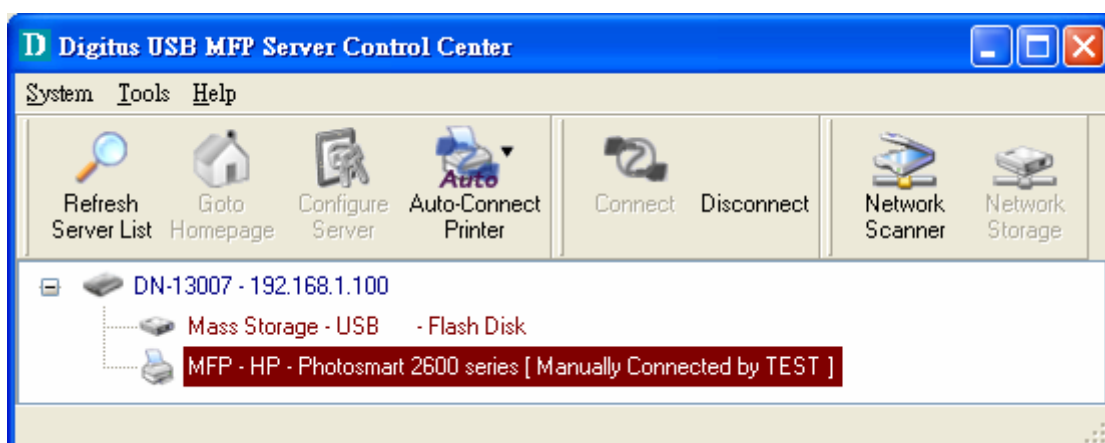



- G. PC will automatically detect the plug-in of the USB device. On the right side of Windows Task Bar, you can see the information of the new device. Continue to follow the user manual of the USB device to do the rest jobs of installation, until the driver installation finished.

After the installation, you can see the newly created devices on the PC. If the USB device is a MFP, you can see a new printer and a new scanner from the "Control Panel".

### 7.3.2 NetUSB Printing

After the driver is installed as described in the previous section, you can see a newly created printer in the Control Panel's "Printers and Faxes". Follow the steps below to do a NetUSB printing.

- A. In the Control Center, click the MFP server that has the desired printer (or MFP) attached.
- B. Click the desired printer (or MFP).
- C. Click the "Auto Connect Printer" button and choose "Set Auto-Connect Printer".

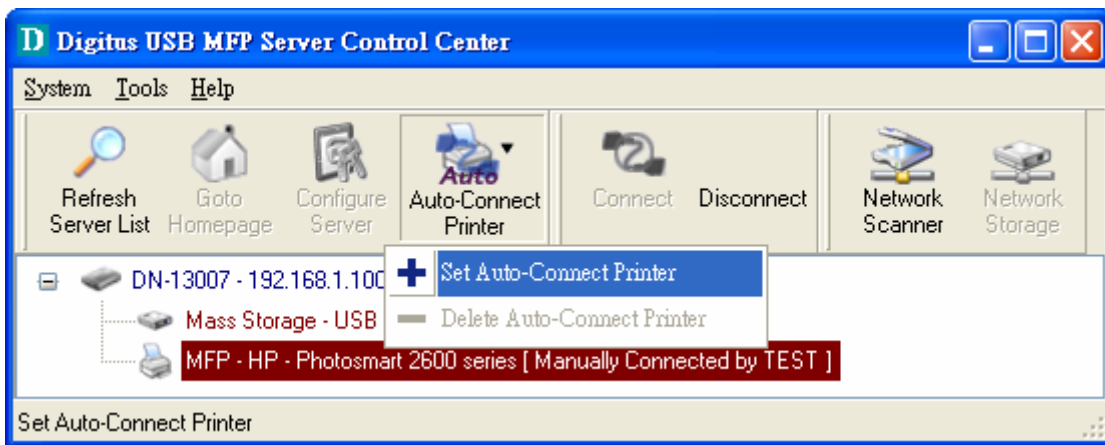

The following figure will appear.

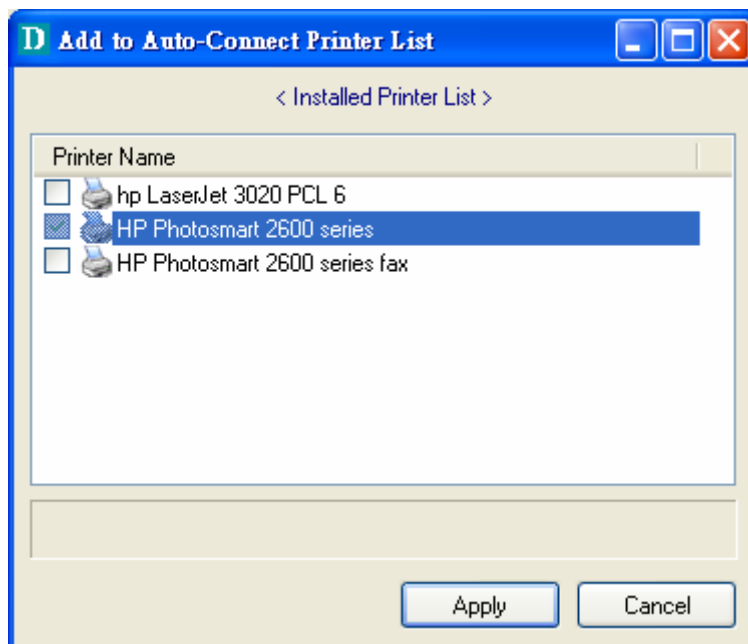

- D. Choose the desired printer. The desired printer must be the Windows printer (this is a logical printer) that matches the printer attached on the MFP server (this is a physical printer). Then click the "Apply" button.
- E. Then, the printer will be marked as an "Auto-Connected Printer" in red. If you choose "Auto-Connected Printer List" in the "Tools" menu, you can see a newly created item that describes the association between the Windows printer and the physical printer on the server.

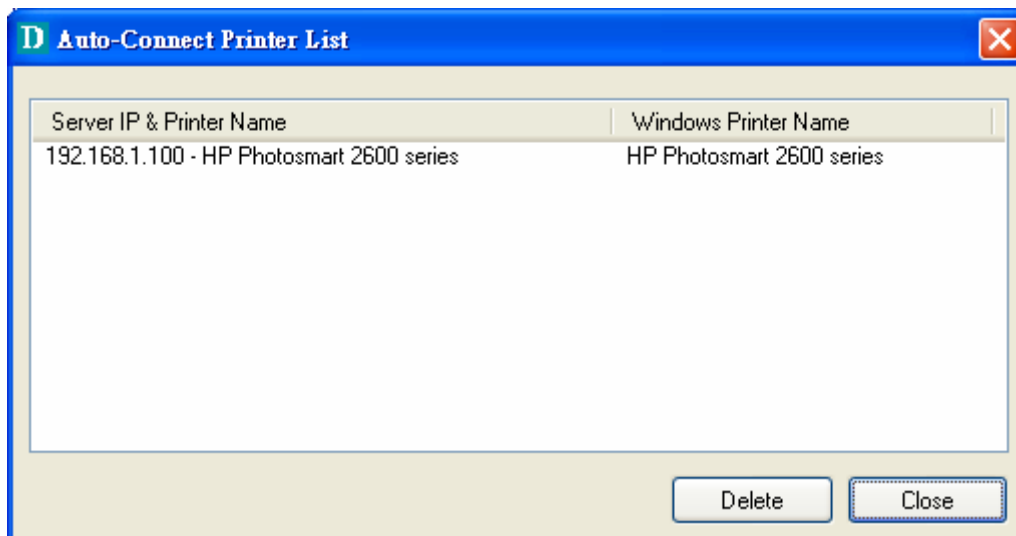

- F. Then try to issue a print job to the desired printer. You will see the Control Center will automatically do a connect operation. Then, the print job will be issued to that printer. This is so-called "Auto Connect Print" operation.
- G. Of course you can issue print jobs using manual "connect" and "disconnect" rather than "Auto Connect Print". To do this, click on the printer, then click the "Connect" button. The name of the computer that has the ownership of the printer will be shown after the printer in the Control Center. Now you can issue print jobs to this printer. After all print jobs are finished, click the "Disconnect" button.
- H. Even you already properly setup an auto-connected printer, the Control Center must be running while a print job is issued. This means you'd better run the Control Center every time after you login Windows. In order to skip this manual operation, you can make the Control Center be run automatically after you login Windows. To do this, choose the "Configuration" item in the "Tools" menu. The

following window will appear. Click on the check box and then on the "OK" button. This feature is enabled by default.

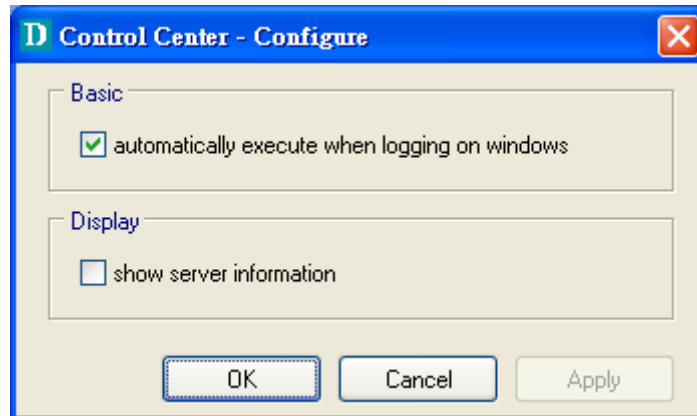

- I. If you would like to break the association between the Windows printer and the physical printer, just click on the association and click the "Delete" button in the "Auto-Connected Printer List".

### 7.3.3 NetUSB Scanning

After the driver is installed as described in 7.3.1, you can see a newly created scanner in the Control Panel's "Scanners and Cameras". Follow the steps below to do a NetUSB scanning.

- A. In the Control Center, click the MFP server that has the desired scanner (or MFP) attached.
- B. Click the desired scanner (or MFP).
- C. Click the "Connect" button to manually connect the scanner (or MFP).
- D. Right-click the scanner icon in the Control Panel's "Scanners and Cameras", and choose "Get picture using Scanner Wizard", as the following figure.

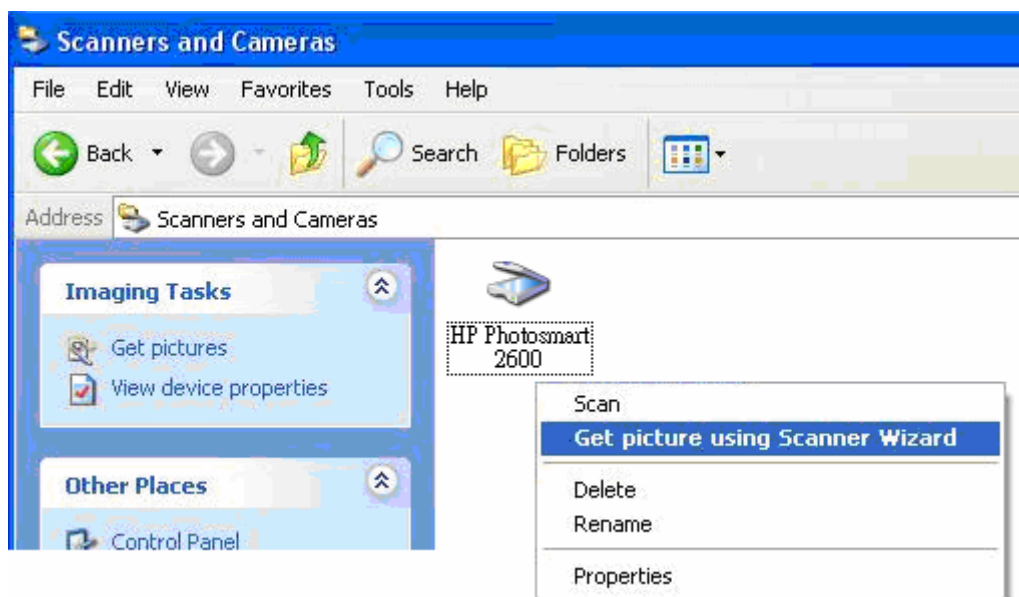

- E. Then the "Scanner Wizard" will run. Set the options as your need. Then submit the scan job.

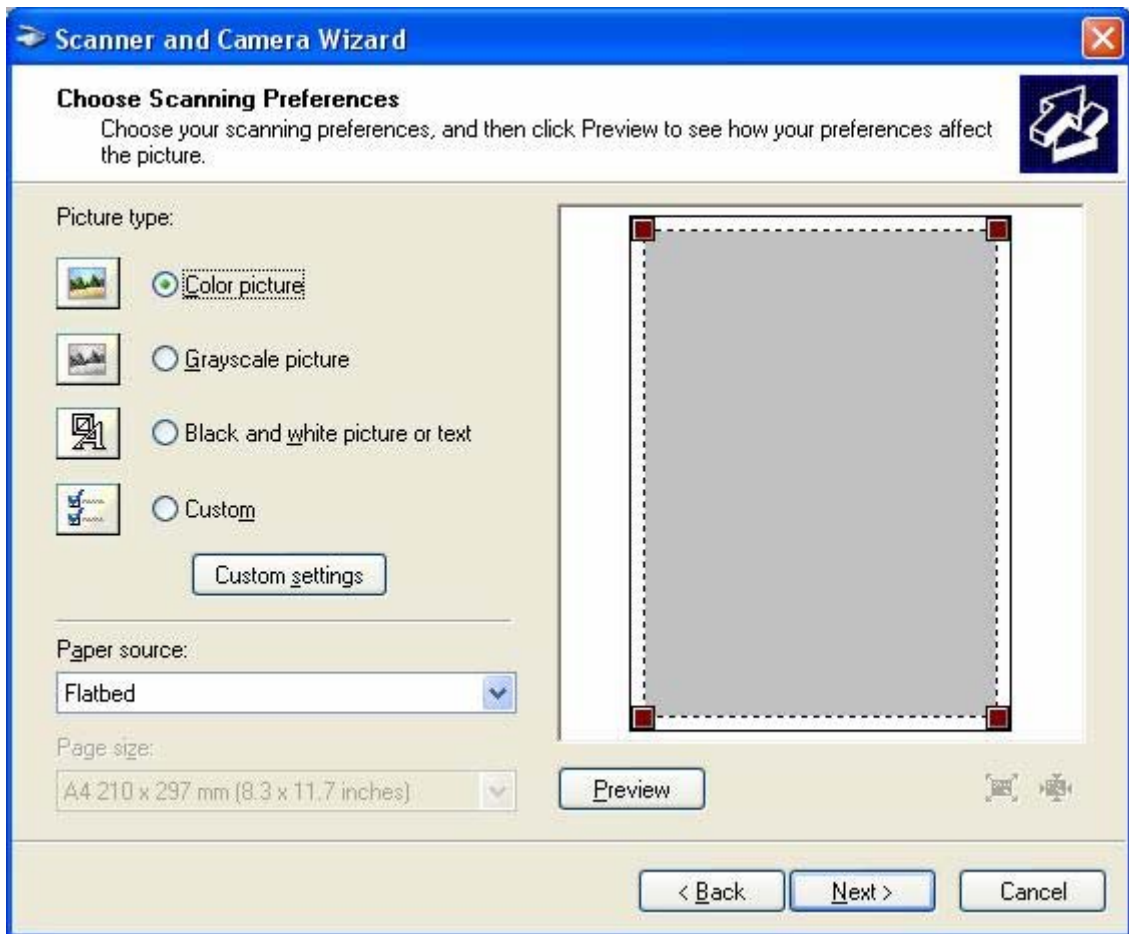

- F. After the scanning finished, click the "Disconnect" button in the Control Center to release the ownership of the scanner (or MFP).

The steps described above require manual "connect" and "disconnect" operations before and after the scanning, respectively. We will introduce "auto-connect scanning" in the following section.

#### 7.3.4 NetUSB Scanning using Auto-Connect Scan

For NetUSB scanning, we recommend you use auto-connect scan as the following steps.

- A. In the Control Center, click the MFP server that has the desired MFP attached.
- B. Click the desired MFP.



- C. Click the "Network Scanner" button. Then you can see that the Control Center will automatically do a "connect" operation. The following window will appear.

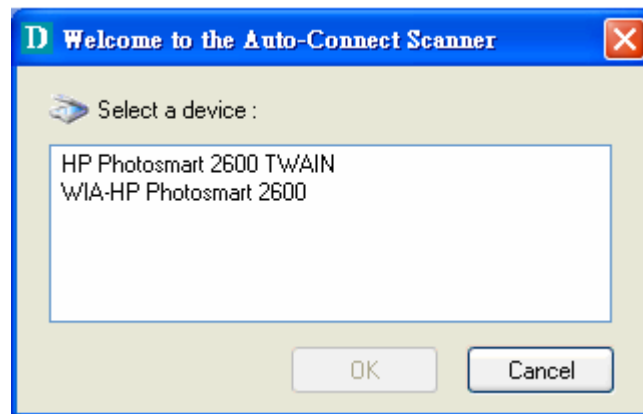

- D. Choose one of TWAIN or WIA item. Click "OK". The following window will appear.

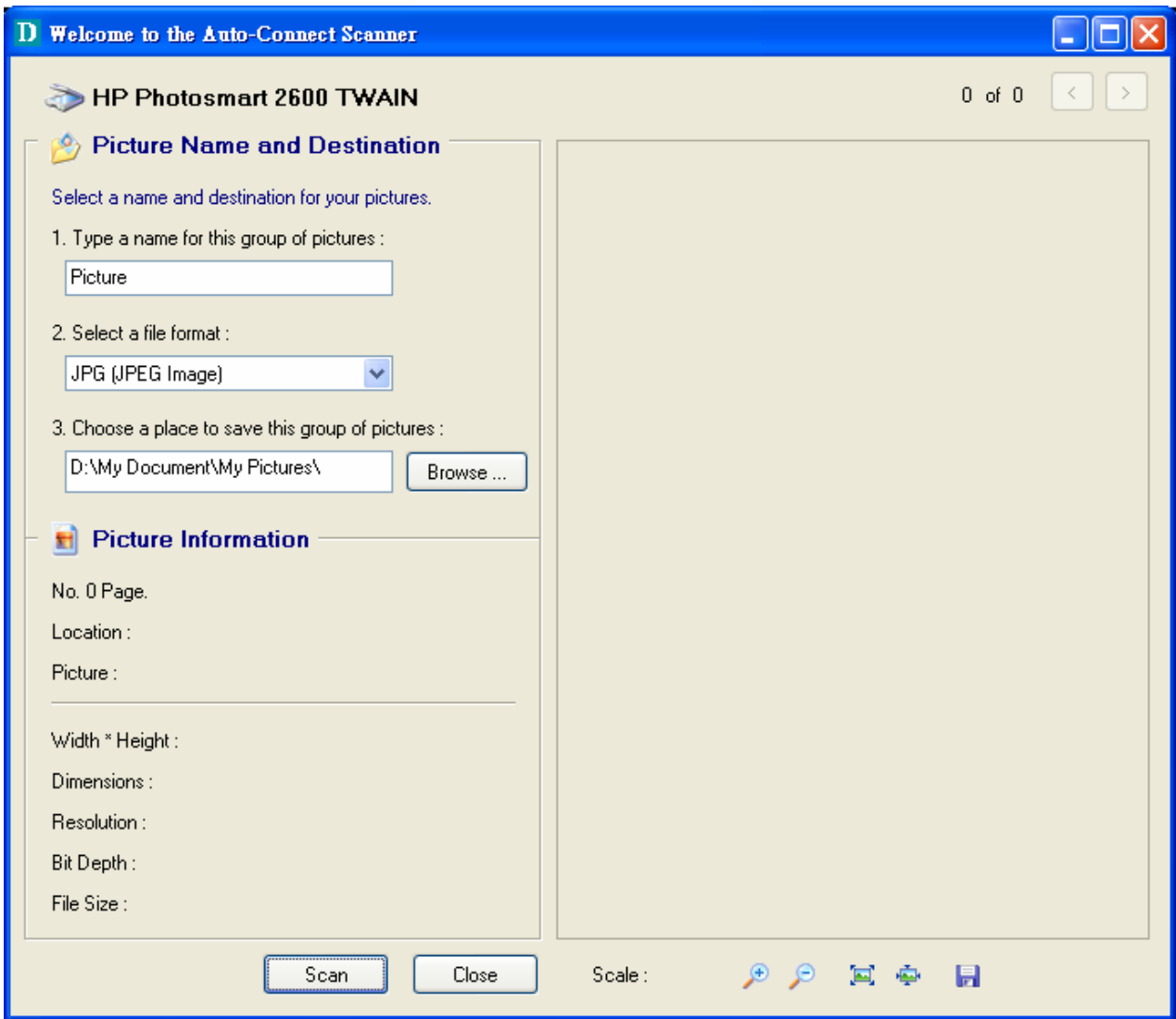

- E. Follow the usual steps to do scanning.
- F. After the scanning, close the "Auto-Connect Scanner" window.

### 7.3.5 Accessing USB Storage using NetUSB Technology

Before you use NetUSB technology to access USB storage, please make sure the storage access mode is in NetUSB mode.

- A. In the Control Center, click the MFP server that has the desired USB storage device attached.
- B. Click the desired USB storage device.

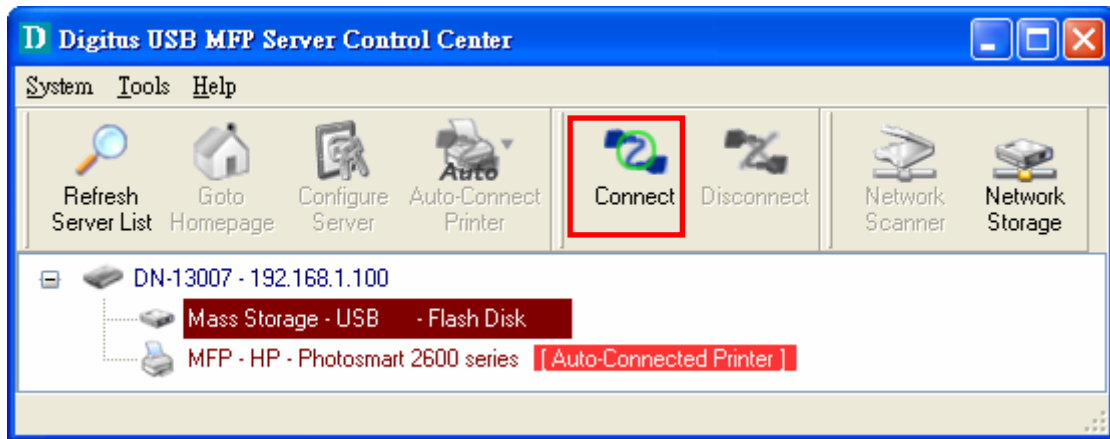

- C. Click the "Connect" button to manually connect the USB storage device.
- D. Now your PC will have a new disk. For example, if you connect a flash drive, your PC will have a new "removable disk". You can see the storage icon in the system tray, as the following figure.

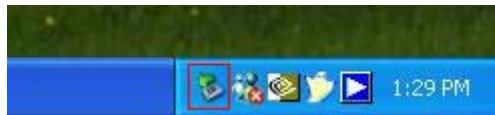

- E. Just use the new disk as a general disk.
- F. After you finish the disk operations, click the storage icon in the system tray and choose "Safely remove USB Mass Storage Device".



- G. In the Control Center, click the "Disconnect" button to disconnect the USB storage device.

Please note that by this way, FAT32 and NTFS file system can be fully supported.

## 7.4 Limitations

There are some limitations to use the NetUSB technology.

- A. Only supports Windows 2000/XP/2003. Windows 98/ME is not supported.
- B. Only one PC can get the ownership of the same USB device at the same time. Moreover, once a USB device is "connected" by a PC so that the PC "owns" that USB device, other PCs can not "access" this USB device by any means. For example, if a printer is connected by a PC using the NetUSB technology, no other PCs can print to this printer by LPR or SMB or IPP protocols, until the printer is disconnected.
- C. For USB storage, although NTFS can be supported by the NetUSB technology, it can not be shared among network users.

# Chapter8 The Control Center

This chapter describes how to use the Control Center.

## 8.1 Installing Control Center

1. Insert the included CD into the personal computer. The Autorun screen as in the following should appear.
2. Click **Install Application** button.
3. Click **Next**, if you see any **Next** button in installation windows.
4. Click **Finish**.

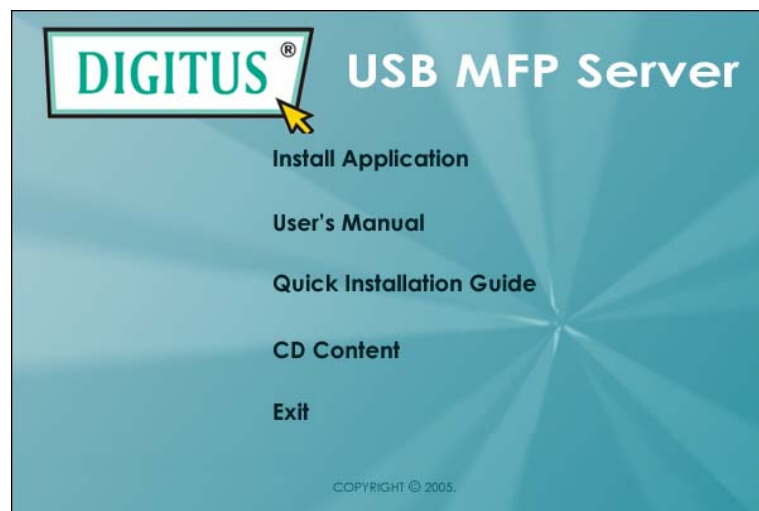

## 8.2 Using the Control Center

### 8.2.1 Using Tools of Control Center

You can use the following tools to help you use the server:



- *Refresh Server List*: renew to auto search the existing servers on the network.
- *Goto Homepage*: go to the web pages of the highlighted MFP server.
- *Configure Server*: configure the highlighted MFP server.

Note 1: You can also right-click the mouse button on the highlighted MFP server to get the "Configure Server", "Goto Homepage", "Set Printer", and "Network Storage" functions.

Note2: You can also double-click on the highlighted server to get the "Configure



Server" function.

## 8.2.2 Displaying Server Status

You can start the Control Center and click on a server to see its status which includes Server Information, TCP/IP status, and Supported Protocols.

## 8.2.3 Setting up Server Configuration

Click the "Configure Server" button to setup the highlighted MFP server. Then type the administrator ID and password to login.

### ■ General Configuration

- ◆ **Server Information:** You have to set some information for using SMB protocol:
  - ☑ *Server Name:* the name to represent the Server for using SMB/CIFS protocol
  - ☑ *Workgroup:* the name of the SMB/CIFS workgroup that the Server belongs to.
  - ☑ *Description:* optionally set to describe the Server
- ◆ **File Server Codepage:** If users want to communicate files using FTP client tool or SMB on Windows 98 SE/Me/2000 with the Server, they have to set their Server codepage to be same as the codepage that their Windows PC is using. Generally, the criteria of choosing codepage are based on your Windows codepage. For example, if your Windows codepage is Traditional Chinese, you have to select Traditional Chinese (Big5) in the Server. Please refer to the chapter "File Server".
- **TCP/IP:** You have to set the Server's TCP/IP configuration to connect TCP/IP network. Please see the chapter of Basic Installation for more details.
- **Supported Protocols:** The Server supports the following TCP/IP protocols:
  - ◆ **TCP/IP**
    - ☑ *Enable LPR (Line Printer Remote) Printing:* select or clear **Enable LPR Printing** support. It is enabled in Factory Default.
    - ☑ *Enable IPP Printing:* select or clear **Enable IPP Printing** support. It is enabled in Factory Default.
    - ☑ *Enable Raw TCP Printing:* select or clear **Enable Raw TCP Printing** support. It is enabled in Factory Default and users may set the protocol's TCP ports as following boxes:
      - *TCP Port 1:* set TCP port for the printer of USB1 port (default: 9100)
      - *TCP Port 2:* set TCP port for the printer of USB2 port (default: 9101)
    - ☑ *Enable SMB/CIFS Print/File Server:* select or clear **Enable SMB/CIFS Print/File Server** support. It is enabled in Factory Default.
    - *Enable Internet Access:* select or clear **Enable Internet Access** support. If you clear the item, you do not allow that users can

access your SMB/CIFS server via Internet. If you select the item, you allow Internet users can access your storage using the SMB/CIFS protocol.

- *Enable Server Authentication:* select or clear **Enable Server Authentication** support. Select the item, if you want to share your storage or printer with user level security which requires user name and password to login. If you clear the item, your storage will be shared without security.
  
- Enable FTP Server:* select or clear **Enable FTP Server** support. It is enabled in Factory Default and users may set some parameters as follows:
  - *FTP Port:* Enter an integer number to set FTP server's TCP port (default: 21)
  - *Set Maximum Session Number:* select or clear **Set Maximum Session Number** support. You can limit the FTP session number by selecting the support and enter an integer to set the allowable maximum session number. If you clear this field it means that FTP server will have no limitation in session number.
  - *Set Passive Mode:* select or clear **Set Passive Mode** support that FTP server can accept passive mode.
  - *Enable Server Authentication:* select or clear **Enable Server Authentication** support. If you select the support, you need to enter user name and password to login to the Server. If you clear the support, you do not need user name and password to enter the Server.
  - *Allow Anonymous Login:* select the item, if you want to allow the user "anonymous" to login to your FTP server with Read-Only permission and FTP server will not check the password. If you clear the item, your FTP server will not support anonymous login function.
  
- Enable UPnP (Universal Plug and Play):* select or clear **Enable UPnP** support. It is enabled in Factory Default.

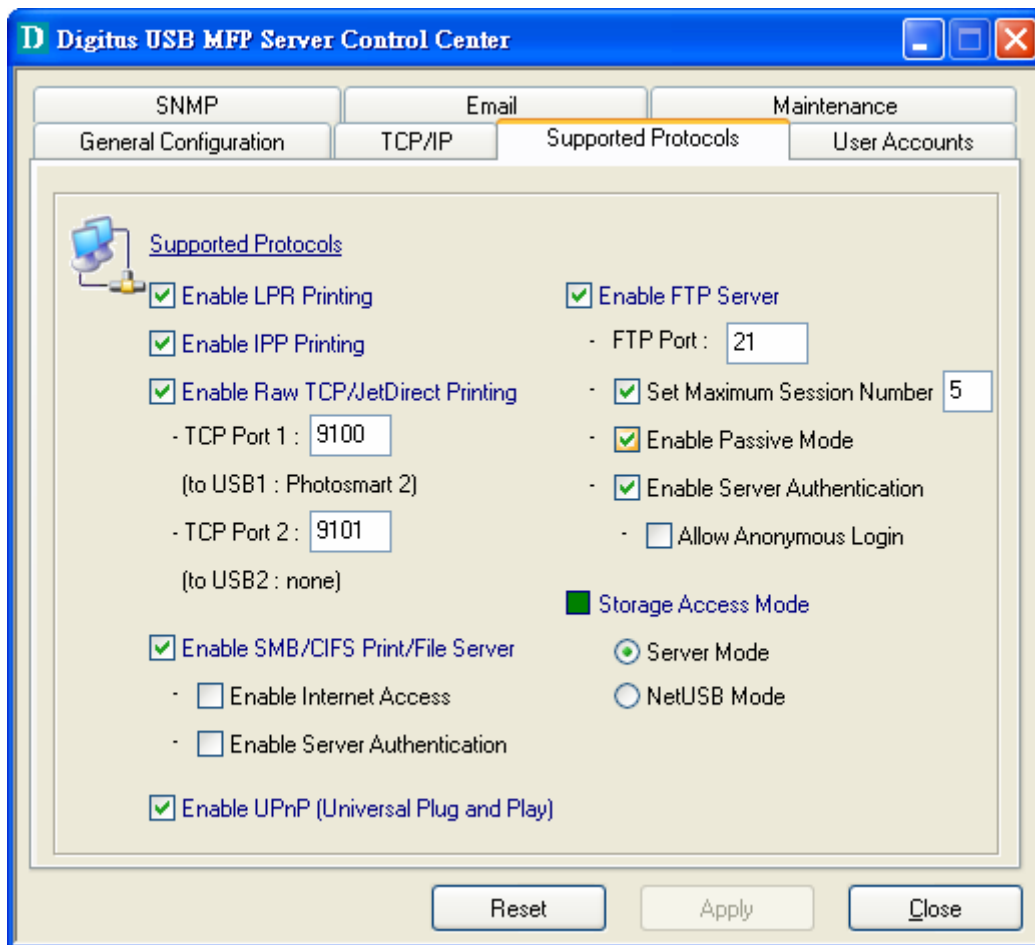

- ◆ **Storage Access Mode**

1. **Server Mode:** In this mode, you can access the USB storage via FTP or SMB/CIFS protocols. FAT16/32 file format is fully supported in this mode. For NTFS, however, only the “read” operation is supported. This is the default mode.
2. **NetUSB Mode:** In this mode, you can access the USB storage using NetUSB technology. FAT16/32 and NTFS file formats are supported, but only one user is allowed to access the storage at the same time. Please refer to chapter 9 for the details about NetUSB technology.

mode	FAT16/32	NTFS	Concurrency
Server	Writable	Read Only	Multiuser
NetUSB	Writable	Writable	Single User

- **User Accounts:** You can change administrator name and password or add a user account for SMB/CIFS Print/File server and FTP File server. If you forgot administrator name and password, you must perform Restore Factory Default action by plugging in the power adaptor while pressing the Init button. Please refer to the chapter “Restore Factory Defaults”. Administrator owns the Read-Write Permission for File servers.

- ◆ **Set Administrator**

- ☑ *New Administrator:* enter your desired administrator name.
- ☑ *New Password:* enter your desired password.

- Retype Password*: confirm your previous password typing.
- ◆ **User Accounts list**
  - User name*: add a new user account for accessing the storage attached to the Server.
  - Password*: set a password for added user.
  - Permission*: select Read-Only or Read-Write permission to access File servers.
  - Add*: click **Add** button, after entering the user name, corresponding password, and Permission selection. The account will take effect once shown in the blank below.
  - Delete*: delete the existing user account.

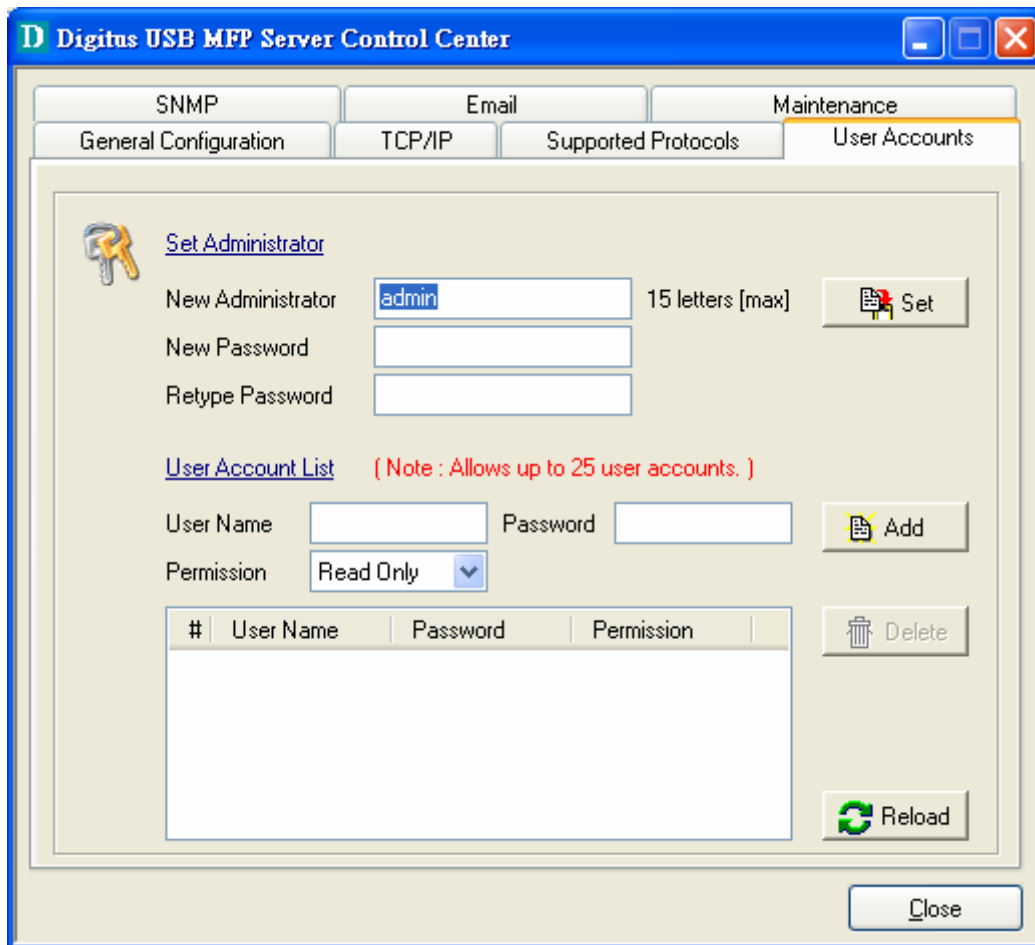

- **SNMP**: You can set community and some parameters for SNMP server. Furthermore, you can enable SNMP v3 for more security.

- ◆ **Set SNMP Configuration**

- Authentic Community*: set Community name of SNMP server.
- Trap Community*: set Trap Community name for SNMP server to send trap packets.
- Trap Address*: enter an IP address to send the Trap packet.
- SysContact*: enter some letters for variable of *SysContact* that represents the name of system contact.
- SysName*: enter some letters for variable of *SysName* that represents the name of system.

- ☑ *SysLocation*: enter some letters for variable of *SysLocation* that represents the location of system.
- ☑ *EnableAuthenTrap*: enter 1 or 2 for the variable of *EnableAuthenTrap* that represents to enable (1) or disable (2) to send Trap packets receiving the wrong Community name.
- ◆ **SNMP V3**
- ☑ *Enable SNMP V3*: select or clear **Enable SnmpV3** support
- ☑ *User Security name*: set user security name of SNMP v3
- ☑ *Auth Password*: set authentication password of SNMP v3.
- ☑ *Privacy Password*: set privacy password of SNMP v3.

- **Email**: If you want to receive some alerting mail from the Server, you have to enable SMTP Protocol, and set Email configuration. You can set new SMTP port number (default: 25).
- ◆ **Set Email Configuration**
  - ☑ *SMTP Protocol*: select or clear **Enable** SMTP support
  - ☑ *SMTP Server Name*: enter your SMTP server's Server Name or IP address.
  - ☑ *SMTP Port Number*: set new SMTP server's TCP port number (default: 25).
  - ☑ *Subject*: enter the subject of the e-mail.
  - ☑ *From Address*: enter the sender's e-mail address.
  - ☑ *To Address*: enter an e-mail address to send that mail to a person.

- ☑ *Cc*: stands for carbon copy; enter an e-mail address to send that mail to a second person.
- ☑ *SMTP Server requires authentication*: login to remote SMTP server which requires authentication.
- ☑ *Account Name*: enter account name for remote SMTP server.
- ☑ *Password*: enter account's password for remote SMTP server.

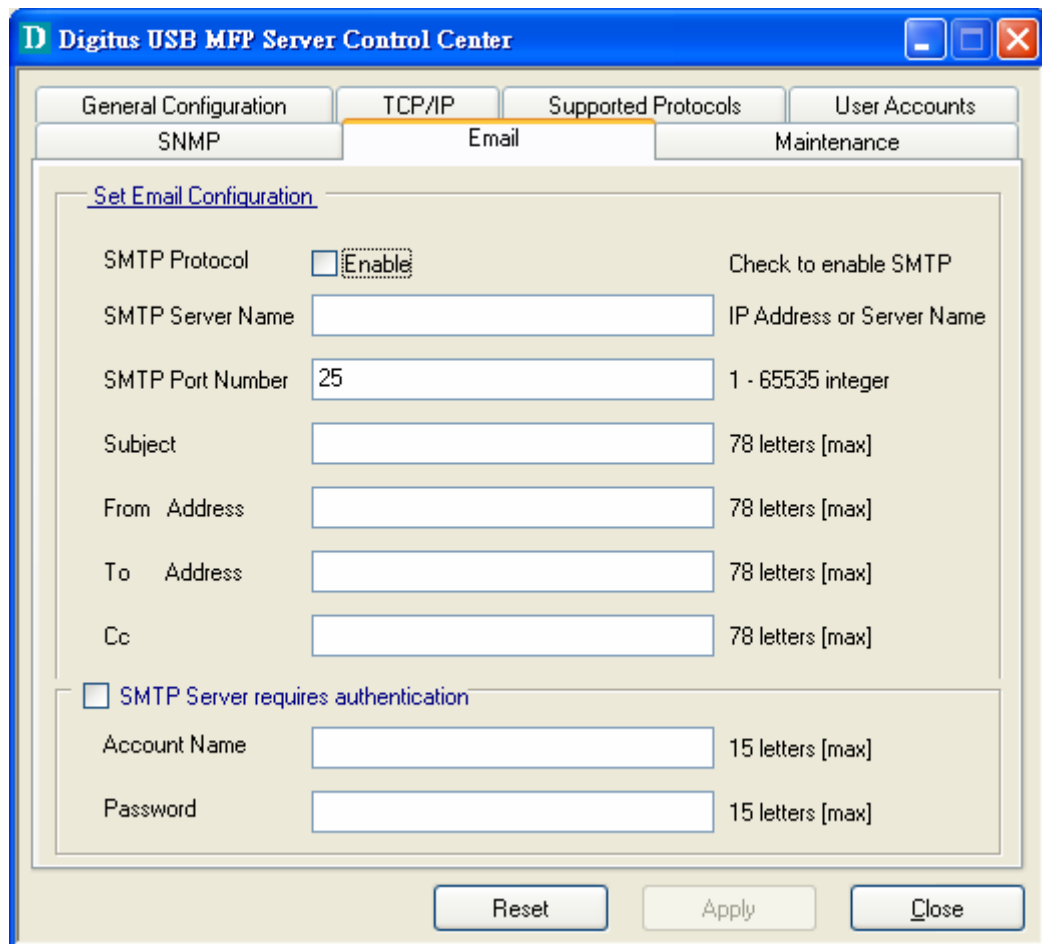

- **Maintenance:** If you want to restart the Server, restore the Server to factory defaults, download new firmware file from product's public website and upgrade new firmware, you can use the Maintenance tool.
  - ◆ **Restart Server:** click this button, the Server will restart.
  - ◆ **Factory Default:** click this button, the Server will restore factory default values.
  - ◆ **Download New Firmware:** click this button to download new firmware or user software from this product's public website.
  - ◆ **Upgrade Firmware:** click **Open** to find the firmware file to be upgraded. Click **Upgrade** to upload the firmware into the Server.

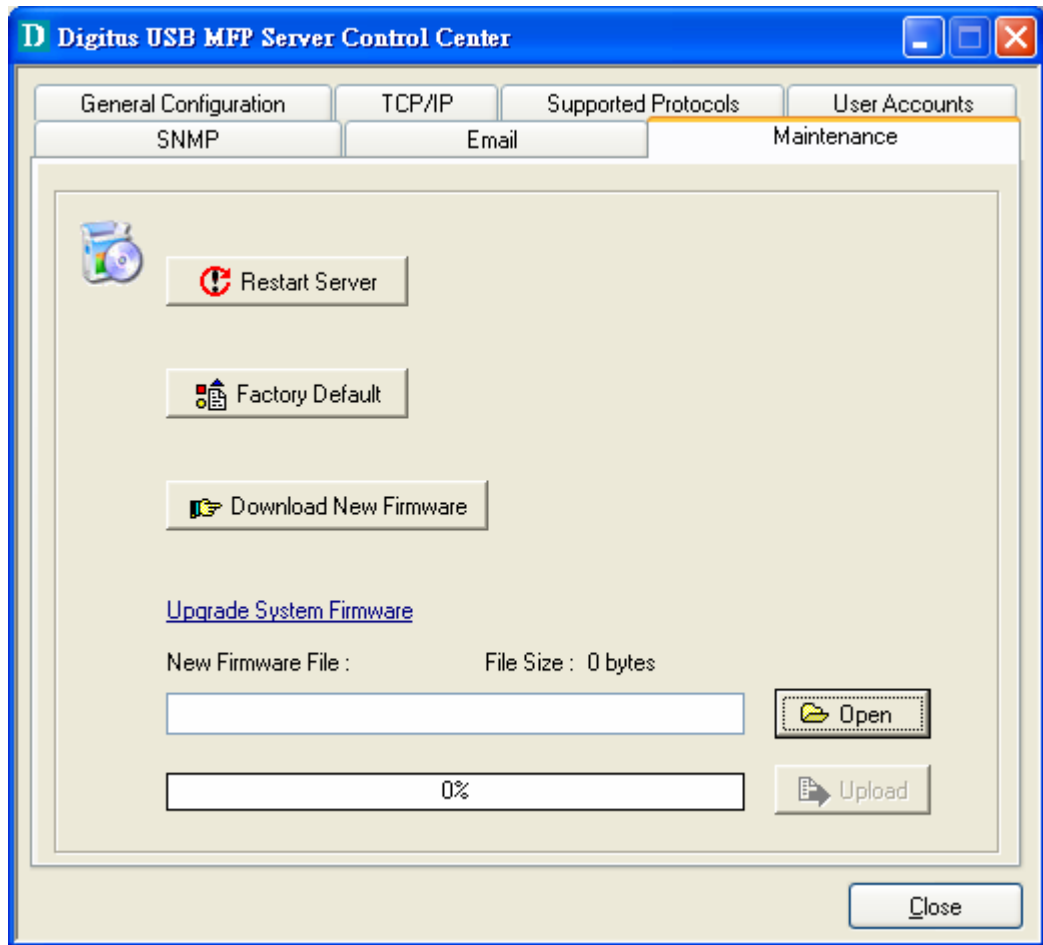

### 8.3 Quitting the Control Center

The Control Center doesn't really quit if you click the "X" box (close box) at the top right corner of the window. Instead, it just minimizes itself to the system tray. There are two ways to really close the Control Center. The first way is choosing "Exit" item in the "File" menu in the Control Center. The second way is right-clicking the icon of the Control Center in the system tray and choosing the "Exit" item.

# Chapter9 The Server's Web Pages

## 9.1 Introduction

The Server runs the daemon of http server, *httpd* on TCP port: 80. Users may use the web pages to see the Server's system status and configure the Server.

## 9.2 Using the Server's Web Pages

### 9.2.1 Displaying Server Status

You can see the status of Host Information, TCP/IP and USB devices.



The screenshot displays the Digitus web interface for the DN-13007 model. The navigation bar includes links for HOME, STATUS (which is highlighted), CONFIG, and CONTACT US. The main content area is titled 'STATUS' and contains several sections of system information:

- System Status**: Includes a [Reload] link.
- Machine Information**:
  - Firmware Version: 2.241
  - Machine Model: DN-13007
- Server Information**:
  - Server Name: DN-13007
  - Workgroup Name: ARBEITSGRUPPE
  - Description: Digitus DN-13007 USB MFP Server
  - File Server Codepage: Western European
- TCP/IP Status**:
  - IP Address : 192.168.1.100 (dhcp failed)
  - Subnet Mask : 255.255.255.0
  - Gateway : 0.0.0.0
  - DNS Server : 0.0.0.0
  - DHCP Server : 0.0.0.0
  - Lease Time : 0 second
- Supported Protocol Status**:
  - TCP/IP:
  - LPR Printing: enabled

On the left side of the page, there is a large graphic of the Digitus logo and the model number DN-13007.



## 9.2.2 Setting up Server Configuration

To set up the Server configuration, the system will request user to enter administrator (default: *admin*) and password (default: *admin*) to login.

### ■ General Configuration

- ◆ **Server Information:** You have to set some information for networking using SMB protocol:
  - ☑ *Server Name:* the name to represent the Server for using SMB protocol
  - ☑ *Workgroup:* the name of the SMB workgroup that the Server belongs to.
  - ☑ *Description:* optionally set to describe the Server
  
- ◆ **File Server Codepage:** if users want to communicate files using FTP client tool or SMB on Windows 98 SE/Me/2000 with the Server, they have to set their Server codepage to be same as the codepage that their Windows PC is using. Generally, the criteria of choosing codepage are based on your Windows codepage. For example, if your Windows codepage is Traditional Chinese, you have to select Traditional Chinese (Big5) in the Server. Please refer to the chapter "File Server".
  
- **TCP/IP:** You have to set the Server's TCP/IP configuration to connect TCP/IP network. Please see Chapter 3 Basic Installation for more details.
  
- **Supported Protocols:** The Server supports the following TCP/IP protocols:
  - ◆ **TCP/IP**
    - ☑ *Enable LPR (Line Printer Remote) Printing:* select or clear **Enable LPR Printing** support. It is enabled in Factory Default.
    - ☑ *Enable IPP Printing:* select or clear **Enable IPP Printing** support. It is enabled in Factory Default.
    - ☑ *Enable Raw TCP Printing:* select or clear **Enable Raw TCP Printing** support. It is enabled in Factory Default and users may set the protocol's TCP ports as following boxes:
      - *TCP Port 1:* set TCP port for the printer of USB1 port (default: 9100)
      - *TCP Port 2:* set TCP port for the printer of USB2 port (default: 9101)
    - ☑ *Enable SMB/CIFS Print/File Server:* select or clear **Enable SMB/CIFS Print/File Server** support. It is enabled in Factory Default.
      - *Enable Internet Access:* select or clear **Enable Internet Access** support. If you clear the item, you do not allow that users can access your SMB/CIFS server via Internet. If you select the item, you allow Internet users can access your storage using the SMB/CIFS protocol.
      - *Enable Server Authentication:* select or clear **Enable Server Authentication** support. Select the item, if you want to share your

storage or printer with user level security which requires user name and password to login. If you clear the item, your storage will be shared without security.

- ☑ *Enable FTP Server:* select or clear **Enable FTP Server** support. It is enabled in Factory Default and users may set some parameters as follows:
  - *FTP Port:* enter an integer number *to* set FTP server's TCP port (default: 21)
  - *Set Maximum Session Number:* select or clear **Set Maximum Session Number** support. You can limit the FTP session number by selecting the support and enter an integer to set the allowable maximum session number. If you clear the support, it means that FTP server will have not any limitation in session number.
  - *Set Passive Mode:* select or clear **Set Passive Mode** support that FTP server can accept passive mode.
  - *Enable Server Authentication:* select or clear **Enable Server Authentication** support. If you select the support, you need to enter user name and password to login to the Server. If you clear the support, you do not need user name and password to enter the Server.
  - *Allow Anonymous Login:* select the item, if you want to allow the user "anonymous" to login to your FTP server with Read-Only permission and FTP server will not check the password. If you clear the item, your FTP server will not support anonymous login function.
  
- ☑ *Enable UPnP (Universal Plug and Play):* select or clear **Enable UPnP** support. It is enabled in Factory Default.

## Set Supported Protocols

TCP/IP	
<input checked="" type="checkbox"/>	Enable LPR Printing
<input checked="" type="checkbox"/>	Enable IPP Printing
<input checked="" type="checkbox"/>	Enable Raw TCP/JetDirect Printing
- TCP Port	<input type="text" value="9100"/> (to USB1 <input type="text"/> )
- TCP Port	<input type="text" value="9101"/> (to USB2 <input type="text"/> )
<input checked="" type="checkbox"/>	Enable SMB/CIFS Print/File Server
- <input type="checkbox"/>	Enable Internet Access
- <input type="checkbox"/>	Enable Server Authentication
<input checked="" type="checkbox"/>	Enable FTP Server
- FTP Port	<input type="text" value="21"/>
- <input checked="" type="checkbox"/>	Set Maximum Session Number <input type="text" value="5"/>
- <input checked="" type="checkbox"/>	Enable Passive Mode
- <input checked="" type="checkbox"/>	Enable Server Authentication
- <input type="checkbox"/>	Allow Anonymous Login
<input checked="" type="checkbox"/>	Enable SANE Server
- SANE Port	<input type="text" value="6566"/>
<input checked="" type="checkbox"/>	Enable UPnP (Universal Plug and Play)
Storage Access Mode	
<input checked="" type="radio"/>	Server Mode
<input type="radio"/>	NetUSB Mode

Submit

Reset

- ◆ **Storage Access Mode**
  1. **Server Mode:** In this mode, you can access the USB storage via FTP or SMB/CIFS protocols. Only FAT16/32 file format is supported in this mode. This is the default mode.
  2. **NetUSB Mode:** In this mode, you can access the USB storage using NetUSB technology. In this mode, FAT16/32 and NTFS file formats are supported, but only one user is allowed to access the storage at the same time. Please refer to chapter 9 for the details about NetUSB technology.
- **User Accounts:** You can change administrator name and password or add a user account for SMB/CIFS Print/File server and FTP File server. If you forgot administrator name and password, you must perform Restore Factory Default action by plugging in the power adaptor while pressing the Init button. Please refer to the chapter "Restore Factory Defaults". Administrator owns the Read-Write Permission for File servers.
- ◆ **Set Administrator**
  - New Administrator:* enter your desired administrator name.
  - New Password:* enter your desired password.
  - Retype Password:* confirm your previous password typing.

- ◆ **User Accounts list**

- ☑ *User name:* add a new user account for accessing the storage attached to the Server.
- ☑ *Password:* set a password for added user.
- ☑ *Permission:* select Read-Only or Read-Write permission to access File servers.
- ☑ *Add:* click **Add** button, after entering the user name, corresponding password, and Permission selection. The account will take effect once shown in the blank below.
- ☑ *Delete:* delete the existing user account.

### Set User Account

Set Administrator		Submit	Reset
New Administrator	<input type="text" value="admin"/>	15 letters [max]	
New Password	<input type="text"/>		
Retype Password	<input type="text"/>		

User Account List			
User Name	<input type="text"/>	Password	<input type="text"/>
Permission	Read Only <input type="button" value="v"/>	<input type="button" value="Add"/>	
User Name	Password	Permission	<input type="button" value="Delete"/>

\*Allows up to 25 user accounts.

- **SNMP:** You can set community and some parameters for SNMP server. Furthermore, you can enable SNMP v3 for more security.

- ◆ **Set SNMP Configuration**

- ☑ *Authentic Community:* set Community name of SNMP server.
- ☑ *Trap Community:* set Trap Community name for SNMP server to send trap packets.
- ☑ *Trap Address:* enter an IP address to send the Trap packet.
- ☑ *SysContact:* enter some letters for variable of *SysContact* that represents the name of system contact.
- ☑ *SysName:* enter some letters for variable of *SysName* that represents the name of system.
- ☑ *SysLocation:* enter some letters for variable of *SysLocation* that represents the location of system.
- ☑ *EnableAuthenTrap:* enter 1 or 2 for the variable of *EnableAuthenTrap*

that represents to enable (1) or disable (2) to send Trap packets receiving the wrong Community name.

- ◆ SNMP V3
  - Enable SNMP V3*: select or clear **Enable SnmpV3** support
  - User Security name*: set user security name of SNMP v3
  - Auth Password*: set authentication password of SNMP v3.
  - Privacy Password*: set privacy password of SNMP v3.

### Set SNMP Configuration

Name	Value	Comment
Authentic Community	<input type="text" value="public"/>	15 letters [max.](Password)
Trap Community	<input type="text" value="public"/>	15 letters [max.]
Trap Address(IP)	<input type="text" value="0.0.0.0"/>	IP address
SysContact	<input type="text" value="My_Email_Address"/>	60 letters [max.]
SysName	<input type="text" value="Digitus DN-13007 USB Mf"/>	60 letters [max.]
SysLocation	<input type="text" value="www.digitus.info"/>	120 letters [max.]
EnableAuthenTrap	<input type="text" value="2"/>	1: Enable, 2: Disable
<input checked="" type="checkbox"/> <b>Enable SNMP V3</b>		
User Security Name	<input type="text"/>	8 - 15 letters
Auth Password	<input type="text"/>	8 - 15 letters
Privacy Password	<input type="text"/>	8 - 15 letters

- **Restart Server**: click this button, the Server will restart.

## CONFIG

- General Configuration
- TCP/IP
- Supported Protocols
- User Accounts
- SNMP
- Email
- Restart Server
- Maintenance

### Restart this server?

This server will be disconnected from the network for a while until it has restarted successfully!

- **Maintenance** If you want to restore factory default values of the Server and

upgrade new firmware, you can use the Maintenance tool.

- ☑ **Factory Default:** click this button, the Server will restore factory default values.
- ☑ **Download New Firmware from Website:** click this button to download new firmware or user software from this product's public website.
- ☑ **Upgrade Firmware:** click **Open** to find the firmware file to be upgraded. Click **Upgrade** to upload the firmware into the Server.



## **Chapter10      Email Alerting**

This Server emails a notification to the user at these events:

1. *Adding or Removing a USB device.*
2. *System Error.*

## **Chapter11      SNMP**

This Server runs an SNMP daemon supporting SNMP v1, v2c, and v3 protocols (Simple Network Management Protocol). Users can use SNMP client software such as HP OpenView to manage the Server. The Server supports all relevant parts of MIB-II and a private MIB. You can set these MIB variables from the Server's web pages or by using the Control Center.

## Chapter 12 Troubleshooting

This chapter provides useful information to help you resolve difficulties that you may experience with your Server. Fault symptoms, possible causes, and remedial actions are provided within a quick reference table. This Server's USB ports only support MFPs, printers, scanners, and mass storage.

### 12.1 LED Indicators

Indicators	Behavior	Description
Power	On	Power On
	Off	Power off/System error
Link	On	Network connected
	Off	No physical connection to network
Status	Blinking	Activity on network
	Off	No activity on network
USB1	On	USB device connected
	Blinking	Connected USB device error
	Off	No physical connection to USB device
USB2	On	USB device connected
	Blinking	Connected USB device error
	Off	No physical connection to USB device

### 12.2 Firewall

If a firewall software has been installed on your PC, it may block the communication between the PC and the MFP server so that the MFP server can not work properly. To solve this problem, either disable the firewall or configure the firewall to allow the following TCP and UDP ports:

7303, 7305, 20005, 30201, 30202, 30203



## Chapter13 Restore Factory Defaults

You may restore the Server's default parameters by one of the following methods.

### 13.1 Using the Control Center

1. Start the Control Center.
2. If the tool finds Servers in your local area network, then you have to select a Server from the Server List.
3. Double click the highlight list and enter the Server's administrator (default: *admin*) and password (default: *admin*).
4. After you have logged in successfully, from the Server menu, select **Maintenance**. The **Maintenance** dialog appears.
5. Click **Factory Default**.

### 13.2 Using the Server's Web Pages

1. Go to the Server's web page and click **CONFIG**
2. Enter administrator (default: *admin*) and password (default: *admin*).
3. Click **Maintenance**.
4. Click **Factory Default**.

### Load the Factory Default?

**This server will load the factory default and then restart!**

Yes

No

5. Click **Yes** to confirm

### 13.3 Using Init Button

Plug in the power adaptor while pressing the Init button until LED indicators of Power, USB1 and USB2 blink. After that, plug off the power adaptor and then plug in the power adaptor again to restart the Server. Finally, the Server will operate using the Factory Default values.

## 13.4 Default Parameters List

### Host Information

- Server Name: **DN-13007** or **DN-13008** or **DN-13018**
- Workgroup: **ARBEITSGRUPPE**
- Description (Optional): **Digitus DN-13007 (or DN-13008 or DN-13018) USB MFP Server**
- Code Page of File Server: **Western European**

### TCP/IP

- Automatically get IP by DHCP: **Enabled**
  - Manual DNS: **None (Disabled)**.
- Static IP: **Disabled**
  - IP Address: **192.168.1.100**
  - Subnet Mask: **255.255.255.0**
  - Default Gateway: **none**
  - DNS Server: **none**

### Supported Protocols

- LPR Printing: **Enabled**
- IPP Printing: **Enabled**
- Raw TCP/JetDirect Printing: **Enabled**
  - TCP Port (USB1): **9100**
  - TCP Port (USB2): **9101**
- SMB/CIFS Print/File Server: **Enabled**
  - Internet Access: **Disabled**
  - Server Authentication: **Disabled**
- FTP Server: **Enabled**
  - FTP Port: **21**
  - Set Maximum Session Number: **5 (Enabled)**
  - Passive Mode: **Enabled**
  - Server Authentication: **Enabled**
  - Allow Anonymous Login: **Disabled**
- UPnP: **Enabled**
- Storage Access Mode: **Server Mode**

### User Accounts

- Administrator: **admin**
- Password: **admin**

### SNMP

- Authentic Community: **public**
- Trap Community: **public**
- Trap Address: **0.0.0.0**

- SysContact: **My\_Email\_Address**
- SysName: **Digitus DN-13007 (or DN-13008 or DN-13018) USB MFP Server**
- SysLocation: **www.digitus.info**
- EnableAuthenTrap: **2 (disable)**
- SNMPv3: **Disabled**
  - User Security Name: **None**
  - Auth Password: **None**
  - Privacy Password: **None**

## **Email**

- SMTP Protocol: **Disabled**
- SMTP Server Name: **None**
- SMTP Port Number: **25**
- Subject: **None**
- From Address: **None**
- To Address: **None**
- Cc: **None**
- SMTP Server requires authentication: **Disabled**
  - Account Name: **None**
  - Password: **None**

# Chapter 14 Upgrade Firmware

This chapter describes how to upgrade firmware. Please follow one of the following Procedures:

## Procedure A: Using the Control Center

1. Open Control Center. It will automatically search the existing Servers and display their statuses.
2. Select the Server that you want to upgrade the firmware. Double click the selected Server and enter Administrator (default: *admin*) and Password (default: *admin*).
3. Select the **Maintenance** button.
4. Click **Open** to find your new firmware file and click **Upload** to start upgrading the firmware.
5. Wait for 20 seconds for system reboot.

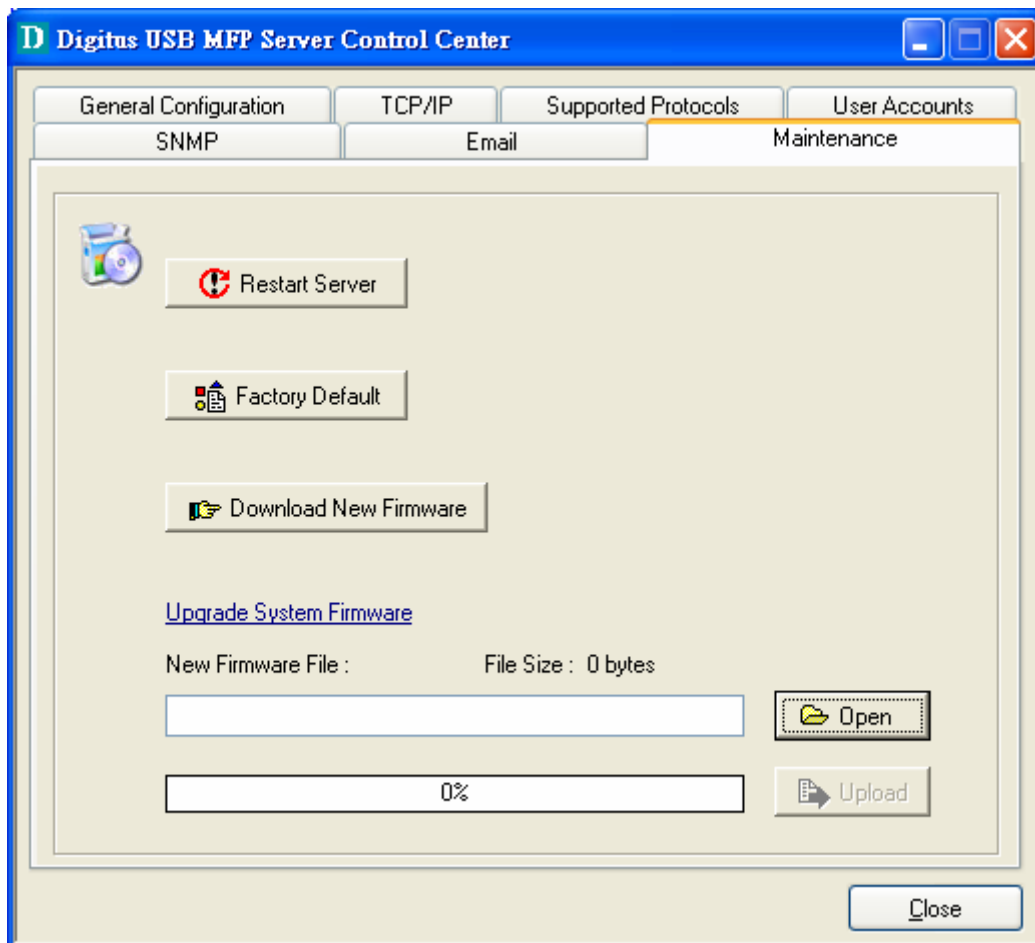

## Procedure B: Using the Server's Web Pages

1. Power on the Server. Suppose that the Server is in DHCP mode.
2. Check the Server's IP address.

3. First, run Control Center. It will automatically search for Servers on the LAN. Then Servers' IP addresses will be shown in Control Center.
4. Run any Web browser, like Microsoft Internet Explorer. Go to "http://Server's IP address" or "http://Server's Server Name" to access the Server's home page.
5. Click **CONFIG** at the top of the menu.
6. Login the Server with Administrator (default: *admin*) and Password (default: *admin*).
7. Click **Maintenance**.
8. Click **Upgrade Firmware**.



9. Click **Browse** button to choose the file of new firmware.
10. Click **Upload** button to start firmware upgrade.
11. Wait for 15 seconds for system reboot.

### Upgrade System Firmware



### Procedure C: Using the Init Button and the TFTP Client

1. Plug in the power adaptor while pressing the Init button until LED indicators of Power, USB1 and USB2 blink. (For DN-13008, only USB1 LED will blink.)  
***Please note that after that, the Server will operate using the factory default values after restarting, i.e., your Server's configuration will recover to Factory Default values.***
2. Start the TFTP client Tool: *Image Burner*

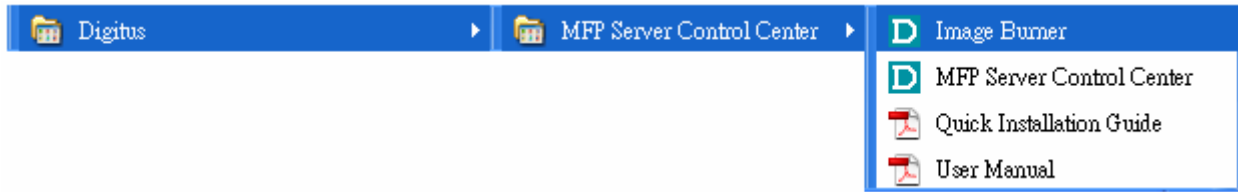

3. Click **Open Image** to open your new firmware. Please note that you must configure your PC's TCP/IP such that PC and the Server belong to the same LAN, i.e. PC's IP is 192.168.1.xxx and subnet mask is 255.255.255.0.

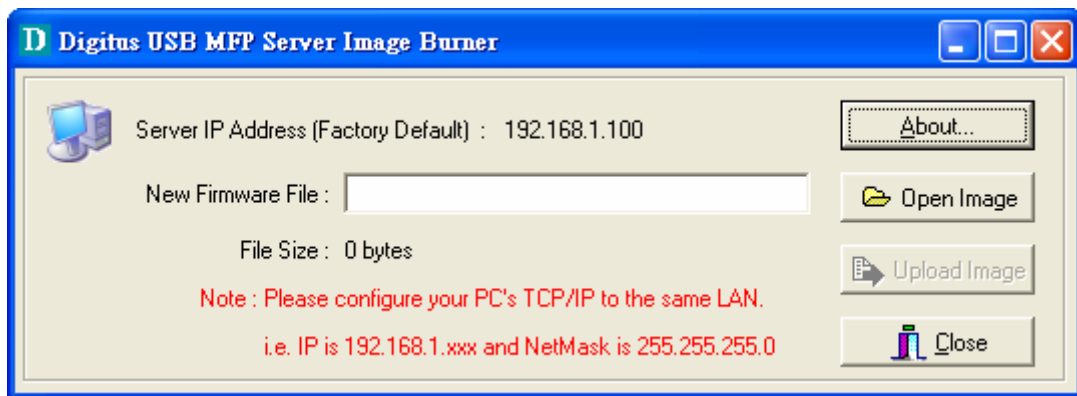

4. Click **Upload Image**.
5. Wait for **Image Uploading** to finish and then click **Close**.
6. Plug-off the power adapter and then plug-in the power adapter to restart the Server.

## Chapter15      The Init Button

The Init button is used for maintenance: Simultaneously press **Init** button and turn on (by plugging in the power adaptor) the Server until USB1 and USB2 LED indicators simultaneously blink. (For DN-13018, only USB1 LED indicator will blink.) After that, the Server will do the following tasks:

- A. Perform a Factory Default of the MFP server, which will restore most of the parameters and settings to factory default values,
- B. Perform a TFTP server. You can upgrade new firmware using any TFTP client tool.

Note: After performing the tasks mentioned above, you have to plug off the power adaptor and then plug in the power adaptor to restart the Server.